



PCR-LE/LE2 SERIES



Broad range of output modes

AC

DC

AC+DC

High-performance multifunctional AC Power Supplies **PCR-LE/LE2 Series**

- Capable of various power line abnormality simulations and the sequence operation
- Single phase 500 VA to 9 kVA/Single phase & three-phase 6 kVA, 9 kVA, 12 kVA, 18 kVA, 27 kVA, Supporting the system for the single-phase, and expandable with optional drivers for the single-phase three-wire, and three-phase operation.
- Expandable capacity up to 27 kVA (single-phase), 54 kVA (single-phase three-line), and 81 kVA (three-phase)
- Features a full range of measuring functions and supports AC, DC, and AC + DC Outputs
- Detachable front panel
- Eco-friendly function equipped
- RS-232C as a standard interface, and GPIB, USB, and LAN (**LXI**) are available as an optional interface.



being smart

**SOLAR
POWER**

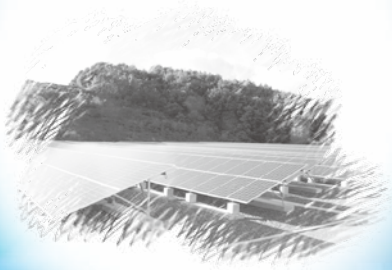

**WIND
POWER**



**FUEL
CELL**





New stage of AC power supply supporting new energy field

High-performance AC Power Supplies PCR-LE SERIES

The PCR-LE Series is a new line of advanced multifunctional AC power supply that has been developed from our PCR-L/LA Series (linear amplifier type).

The PCR-LE Series provides high reliability and can be applied to various applications, by taking advantage of the features that can control broadband waveform freely. Moreover, the PCR-LE Series can be configured as a core device of a test system combined with E-loads and Power Analyzers for "Grid Connection Testing" in regard to dispersed power generation, such as Solar Power, Wind Power, Fuel Cell, and Gas Engine referred to as "New Energy Field". With various options, the low frequency immunity test and various power environment tests are supported. The options for parallel operation and three-phase operation enable you to expand a single-phase system up-to 27 kVA, single-phase three wires up-to 54 kVA, and a three-phase system up to 81 kVA. The system can be applied to a large-scale EMC site for testing of industrial high-capacity air conditioners.

[Applications]

▶ Research & Development

Proof evaluation for power supply abnormality, EMC testing

▶ Adjustment & Inspection Lines

Power supply voltage margin check, Automated inspection system

▶ Production Lines

For stabilizing the line power supply, Automated testing system

▶ Quality Assurance

IE and Testing



▶ After-Sales Service

As power supply for repair and calibration

To reproduce power line abnormalities

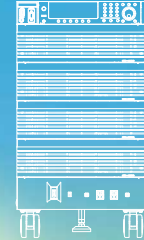

● Lineup

Model	PCR500LE	PCR1000LE	PCR2000LE	PCR3000LE	PCR4000LE	PCR6000LE	PCR9000LE
Output capacity	Single-phase 500 VA	Single-phase 1 kVA	Single-phase 2 kVA	Single-phase 3 kVA	Single-phase 4 kVA	Single-phase 6 kVA	Single-phase 9 kVA
Maximum output current	5 A / 2.5 A	10 A / 5 A	20 A / 10 A	30 A / 15 A	40 A / 20 A	60 A / 30 A	90 A / 45 A
AC mode (L/H range)	1 V to 150 V / 2 V to 300 V						
	5 A / 2.5 A	10 A / 5 A	20 A / 10 A	30 A / 15 A	40 A / 20 A	60 A / 30 A	90 A / 45 A
DC mode (L/H range)	1.4 V to 212 V / 2.8 V to 424 V						
	3.5 A / 1.75 A	7 A / 3.5 A	14 A / 7 A	21 A / 10.5 A	28 A / 14 A	42 A / 21 A	63 A / 31.5 A
Dimensions (mm/inches) (Maximum dimensions)	430 (16.93") W	430 (16.93") W	430 (16.93") W	430 (16.93") (445 (17.52")) W	430 (16.93") (445 (17.52")) W	430 (16.93") (445 (17.52")) W	430 (16.93") (445 (17.52")) W
	173 (6.81") (195 (7.68")) H	262 (10.31") (345 (13.58")) H	389 (15.31") (475 (18.70")) H	690 (27.17") (785 (30.91")) H	690 (27.17") (785 (30.91")) H	944 (36.17") (1040 (40.94")) H	1325 (52.17") (1420 (55.91")) H
	550 (21.65") (600 (23.62")) D	550 (21.65") (595 (23.43")) D	550 (21.65") (595 (23.43")) D	550 (21.65") (595 (23.43")) D	550 (21.65") (595 (23.43")) D	550 (21.65") (595 (23.43")) D	550 (21.65") (595 (23.43")) D
Weight	Approx. 17 kg (37.4 lbs)	Approx. 35 kg (77.1 lbs)	Approx. 55 kg (121.2 lbs)	Approx. 82 kg (180.7 lbs)	Approx. 96 kg (211.6 lbs)	Approx. 140 kg (308.6 lbs)	Approx. 190 kg (418.8 lbs)
Appearance							

4 kVA

3 kVA

2 kVA

1 kVA

500 VA



advantage



The linear amplifier type realizes high stability and high quality output and supports a wide range of functions from R&D to manufacturing/inspection lines and servicing.

What is a linear amplifier type?

Firstly, the input power is converted to DC power by a rectifier circuit, then it supplies the power as the linear amplifier.

A sine wave reference voltage is created by such a crystal oscillator, and it is used as input into the linear amplifier, where the power amplification is performed to generate the output power.

In addition to its high-speed response characteristics, because the output voltage and frequency can be changed whenever necessary, this system can be used to conduct simulations of power line abnormalities (such as instantaneous power interruption tests), and also it can be applied to the testing of ATE and other purposes.

What is a PWM inverter?

This type uses a PWM (Pulse Width Modulation) switching-type DC/AC inverter which is placed as a part instead of the linear amplifier.

Because this is a switching type, it cannot provide feedback over a wide range while the linear amplifier can. As a result, the output quality and response gets inferior, and noise becomes larger, compared to the linear amplifier type.

However it has the advantages of being smaller and more efficient than the linear amplifier type, and is also pulling attention as a high-performance AC power supply for energy-saving purposes.

List by PCR-LE applications

Mode	Category	Tested device	Test contents	Refer to page
AC	Product tests	Home electronics, office equipment, industrial equipment	Power fluctuation tests	12 to 14
			IEC61000 standard low-frequency immunity tests	
			Reproduction and evaluation of voltage abnormalities in the market	
	Component tests	Power conditioners	Power regeneration tests	12 to 13
AC/DC converters		Power fluctuation tests		
AC + DC DC	Component tests	DC/DC converters	Tests of conversion from high voltage to low voltage Simulations of voltage fluctuations in EV and HEV high-voltage batteries	14
		Capacitors	Ripple current tests of high-voltage capacitors	
AC, AC + DC, DC	Component tests	EV charging systems	Tests of requirements for IEC61851 and ECE R10.04 standards	

■ For R&D:



- Evaluation for the immunity of power abnormalities.
- Capable of DC output.
- Easily conducting power measurement.
- Can be used in anechoic chambers and shield rooms.

The PCR-LE Series has equipped with the measurement functions built into the main unit, it can be used not only for voltage and current measurement, but also for convenient measurement of apparent and effective power, inrush (peak) current, power factor, high-frequency current, and other values. Furthermore, it is capable to conduct such as power line abnormality simulations, sequencing functions, and arbitrary waveform generation also provide a dramatic improvement in data reproducibility and reliability when evaluating immunity to instantaneous power interruptions, voltage fluctuations, frequency fluctuations, missing phase, and other power line abnormalities. In addition, the PCR-LE has maximum DC output of ± 424 V. This is extremely convenient when a slight DC output is required in case driving a DC/DC converter. The PCR-LE Series can also be used as AC power sources in various EMC test sites (anechoic chambers, shield rooms, etc.).

* Use of the arbitrary waveform generation function and other functions requires separate application software SD011-PCR-LE (Wavy for PCR-LE).

■ For Manufacturing lines:



- Use as a CVCF power supply.
- Stabilization of the power line.

With the PCR-LE Series, it can be used as a CVCF power supply to handle worldwide commercial power (100 V - 240 V), as well as for marine and aircraft power (400 Hz). It can supply a maximum output peak current up to 4 times the rating (rms) with a capacitor input load (both peak value and continuous supply), or approximately 2 times the rating (rms) for motors and other loads with large in-rush currents (peak value, approximately 10 seconds*, when power factor is 1). The PCR-LE Series is also recommended for power stabilization when using precision machining systems, measurement systems, and others where the voltage abnormalities becomes an issue. With an output voltage response speed of 30 μ s (standard value) and a waveform distortion factor of 0.3 % or less, the PCR-LE Series provides extremely high speed and high quality that are particularly effective with systems such as welders and semiconductor manufacturing equipment where even slight power fluctuations or load fluctuations can affect quality and accuracy.

*Output shuts off after 10 seconds.

Waveform distortion occurs if the current exceeds the rating anytime during the period of 10 seconds.

■ For Adjustment and Inspection lines:



- To confirm the power voltage margin.
- Use in automated inspection systems.

The PCR-LE Series can be used for operation checks of the power voltage range, and as a power supply for aging. Multiple units of the PCR-LE Series can be connected in parallel to boost capacity, and can also be connected in 3 phases, allowing flexible adaptation to line changes or the number of aging units. Remote control and monitoring from a PC is also supported using the GPIB or RS-232C communication or USB or LAN interface, and it can be used for management of inspection records and other quality data as well.

* The GPIB, USB, and LAN are available as an interface option.

■ For Quality Assurance:

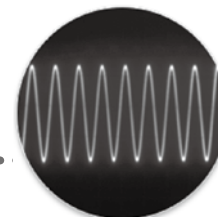

- Use as a standard room power supply.
- Conducting of IEC standard tests.

The PCR-LE Series can be used as a power supply in standard rooms and measurement device management rooms.

■ For After-sales service:



- Use as a power supply for repairs and calibration.
- Reproduction of power abnormalities.

The PCR-LE Series can also make a large contribution to repairs, inspections, calibration, and other servicing work. For example, the PCR500LE (output capacity 500 VA) allows worldwide commercial power (100 V - 240 V) to be supplied from a household electrical outlet (100 V, 15 A). This is highly recommended for servicing sites where large equipment cannot be installed and it also can be used for the field service. Since the PCR-LE Series can supply clean power that is free of fluctuation or distortion for inspection and calibration work, it can help to maintain and improve quality of service.

features

Extended system for large capacity applications. Flexible configuration in models.

It is possible to expand to 27 kVA (single phase), 54 kVA (single phase 3-wire), and 81 kVA (three phase) by using the parallel, single phase 3-wire, and three phase operation options (expansion operation drivers). This allows the system to be used for large-scale EMC site power or as test power for large-capacity industrial air conditioners.



Extensive configuration of the system.

Each unit can be used as either a master or slave, allowing units to be individual or system depends on the requirement.

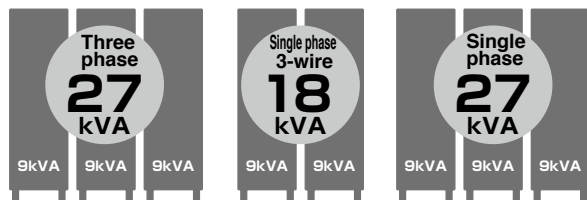

Parallel operation

*The separately-sold expansion operation driver is required. Can be expanded to 54 kVA (single phase 3-wire) or 81 kVA (three phase) when used in combination with the single phase 3-wire option or three phase option.

★ Combinations of different models are possible!
Example: PCR2000LE + PCR4000LE + PCR6000LE = Single phase 12 kVA



Single phase 3-wire, three phase operation

* The separately-sold expansion operation driver is required.

All models / Max. expanded capacity: 54 kVA (single phase 3-wire), 81 kVA (three phase)

When used in combination with the parallel operation option

★ Combinations of different models are possible!
Example: PCR2000LE + PCR2000LE + PCR4000LE = 6kVA "Three-phase" or 8kVA "Unbalanced Three-phase"

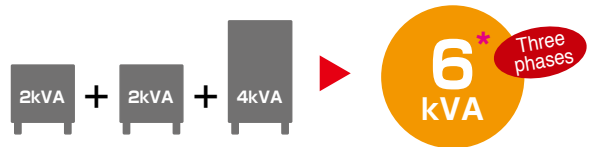

*8kVA when used in the "Unbalanced Three-phase"

For testing of the "Grid connected system" with reverse load flow

Conforming to the guideline of the Japanese standard requirements of system interconnection technologies

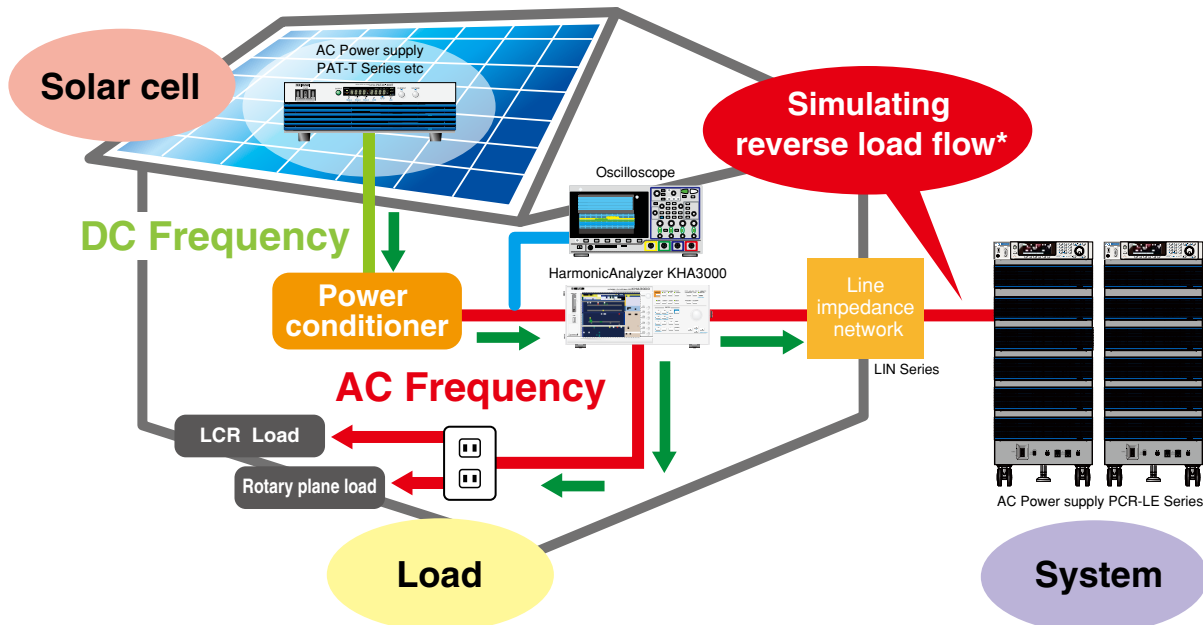

*All the simulated reverse load flow power is consumed internally, thus, there will be no reverse load flow to the system.

Eco-friendly function (Energy-saving function)

■ Sleep function

The power unit goes into the sleep mode when no output is detected for a specified period to save the power consumption.

PCR4000LE

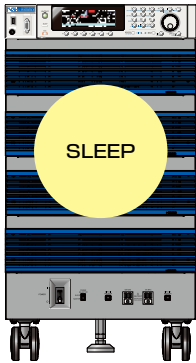

■ Energy-saving operation function*

You can utilize the energy-saving function to operate only the number of power unit(s) depending on the required supply load.

[Example] Operation with a 4 kVA model when 1 kVA is necessary

PCR4000LE

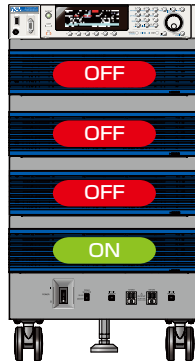

Unit structure allows easy maintenance.

Maintenance (replacement or other work) on the power unit can be performed in 1 KVA units. *Excepting PCR500LE

Downsizing

Comparison with the former model PCR-LA (4 kVA)

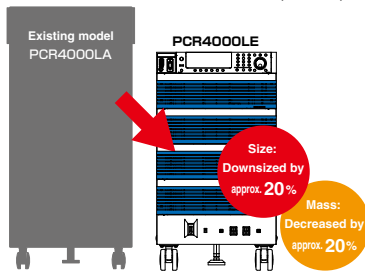

Model	Dimensions (mm(inches))	Weight
PCR4000LE	445 (17.52") W×785 (30.91") H ×595 (23.43") D mm	96 kg (211.64 lbs)
PCR4000LA	455 (17.91") W×920 (36.22") H ×605 (23.82") D mm	120 kg (264.55 lbs)

Input/output terminal block tray for easy connections

The rear input/output terminal block tray is a slide-out type, allowing input/output cables to be connected easily. (Excepting the PCR500LE and PCR12000LE2 and PCR18000LE2 and PCR27000LE2)



Normal use

When terminal block tray slides out

*In case the terminal block tray is not returned into the storage compartment, the PCR-LE2 can not be operated even if the power switch is turned on.

Wide-ranging specs DC output also supported

Item	Range
Voltage (AC)	1V to 150 V (L range), 2V to 300V(H range)
Frequency	1Hz to 999.9 Hz *1
Voltage (DC/AC+DC)	1.4 V to 212 V (L range), 2.8 V to 424 V (H range)

*1: The frequency is limited to the range from 1 Hz to 500.0 Hz when the 3P05-PCR-LE(500Hz LMT) is installed in the PCR-LE series.

In addition, the system supports a DC output mode and AC + DC output mode. The system can be useful in a wider range of fields such as chemistry- and physics-related areas.

Selectable response mode

Allows select of a response mode for the internal amplifier system depending on the load condition and application.

Item	Application
High-speed response (FAST)*2	for requesting a rate of power rise/fall
Normal response (MEDIUM)	for testing various power supply environments
Highly stable response (SLOW)	for power supply for EMC testing sites

*2 : Excluding PCR6000LE, PCR9000LE, PCR6000LE2, PCR9000LE2, PCR12000LE2, PCR18000LE2, PCR27000LE2, three phase operation, parallel operation

Power line abnormality simulation

In AC mode, it is possible to simulate power line abnormalities by setting the output of the PCR-LE series system to the state of a power outage, voltage drop (dip), or voltage increase (pop). This allows the ability to test switching power supplies and electronic equipment.

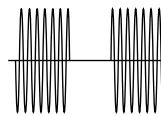

power outage

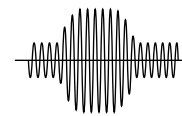

voltage increase (pop)

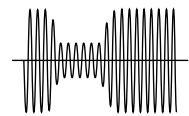

voltage drop (dip)

External communication interface. Complied to LXI.

RS232C (equipped as a standard). Remote control available with GPIB, USB, and LAN as options. Using LAN makes it possible to configure highly cost-effective systems, as LXI standard is supported.

Other functions

- Various measuring functions
- Sequence function
- Sensing
- Regulation adjustment
- Output current control
- Setting output impedance
- Measuring harmonics current
- Soft start (Rise time control)
- Internally fixed Vcc
- Control panel angle adjustment



The control panel angle can be adjusted according to the position where it is used. The optional control panel extension cable is also available. (See P. 18.)

performance

[Example of single phase 3-wire 4 kVA system]

● Example of single phase 3-wire system configuration

Capacity	Model	Qty	Single-phase three-wire driver	Qty
Single phase 3-wire 1 kVA	PCR500LE	2	2P05-PCR-LE	1
Single phase 3-wire 2 kVA	PCR1000LE	2	2P05-PCR-LE	1
Single phase 3-wire 4 kVA	PCR2000LE	2	2P05-PCR-LE	1
Single phase 3-wire 6 kVA	PCR3000LE	2	2P05-PCR-LE	1
Single phase 3-wire 8 kVA	PCR4000LE	2	2P05-PCR-LE	1
Single phase 3-wire 12 kVA	PCR6000LE	2	2P05-PCR-LE	1
Single phase 3-wire 18 kVA	PCR9000LE	2	2P05-PCR-LE	1

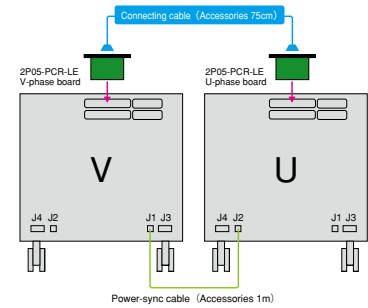

● Example of PCR2000LE parallel operation system configuration

Capacity	Model	Qty	Parallel operation driver (Master)	Qty	Parallel operation driver (Slave)	Qty
Single phase 4 kVA	PCR2000LE	2	PD05M-PCR-LE	1	PD05S-PCR-LE	1
Single phase 6 kVA	PCR2000LE	3	PD05M-PCR-LE	1	PD05S-PCR-LE	2
Single phase 8 kVA	PCR2000LE	4	PD05M-PCR-LE	1	PD05S-PCR-LE	3
Single phase 10 kVA	PCR2000LE	5	PD05M-PCR-LE	1	PD05S-PCR-LE	4

[Example of parallel operation 4 kVA system]

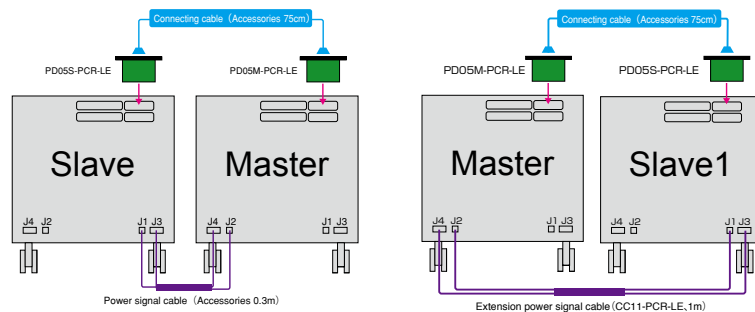

[Example of parallel operation 6 kVA system]

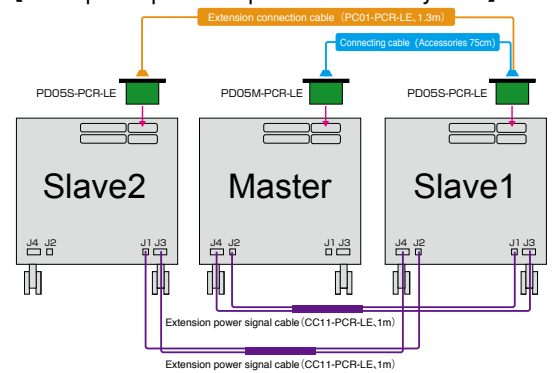

● Example of PCR9000LE parallel operation system configuration

Capacity	Model	Qty	Parallel operation driver (Master)	Qty	Parallel operation driver (Slave)	Qty
Single phase 18 kVA	PCR9000LE	2	PD05M-PCR-LE	1	PD05S-PCR-LE	1
Single phase 27 kVA	PCR9000LE	3	PD05M-PCR-LE	1	PD05S-PCR-LE	2

● Example of three-phase system configuration

Capacity	Model	Qty	Three-phase output driver	Qty
Three phase 1.5 kVA	PCR500LE	3	3P05-PCR-LE	1
Three phase 3 kVA	PCR1000LE	3	3P05-PCR-LE	1
Three phase 6 kVA	PCR2000LE	3	3P05-PCR-LE	1
Three phase 9 kVA	PCR3000LE	3	3P05-PCR-LE	1
Three phase 12 kVA	PCR4000LE	3	3P05-PCR-LE	1
Three phase 18 kVA	PCR6000LE	3	3P05-PCR-LE	1
Three phase 27 kVA	PCR9000LE	3	3P05-PCR-LE	1

[Example of PCR2000LE Three phase 6 kVA system]

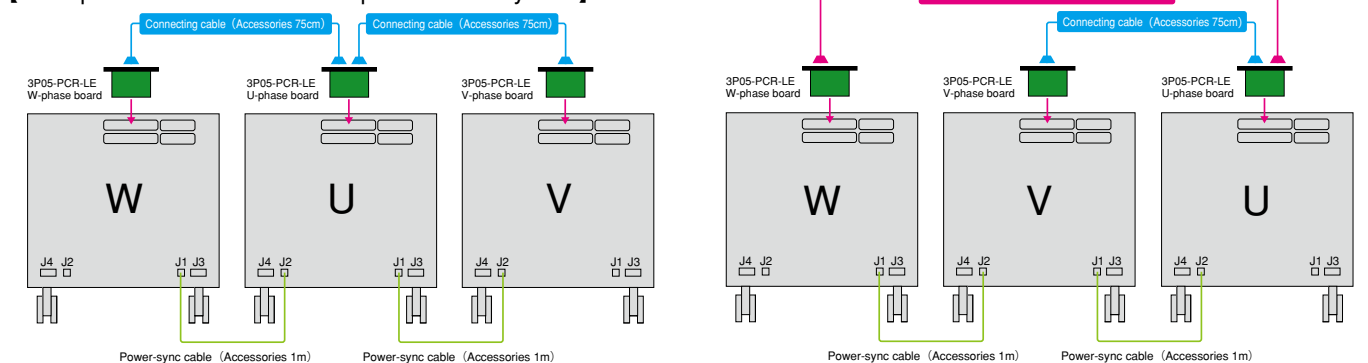

* When the "POWER SELECTOR" of the unit for the "V-phase" is switched to the "Master unit", and the unit for the "U-phase" and the "W-phase" is switched to the "Slave unit".

* An optional extension cable (CC01-PCR-LE or CC02-PCR-LE) is available as needed according to the unit layout.
* When the "POWER SELECTOR" of the unit for the "U-phase" is switched to the "Master unit", and the unit for the "V-phase" and the "W-phase" is switched to the "Slave unit".

* It is not possible to configure the system combined with the parallel operation and the three-phase operation system. Please install the U-phase between the V-phase and the W-phase.

● Example of parallel operation + Three-phase operation system configuration

Capacity	Model	Qty	Part
18 kVA	PCR2000LE	9	AC Power Supplies(2 kVA)
	3P05-PCR-LE	1	Three-phase output driver
	PD05M-PCR-LE	3	Parallel operation driver (Master)
	PD05S-PCR-LE	6	Parallel operation driver (Slave)
	CC02-PCR-LE	2	Extension cable for 2P05·3P05 2.8 m

Capacity	Model	Qty	Part
81 kVA	PCR9000LE	9	AC Power Supplies(9kVA)
	3P05-PCR-LE	1	Three-phase output driver
	PD05M-PCR-LE	3	Parallel operation driver (Master)
	PD05S-PCR-LE	6	Parallel operation driver (Slave)
	CC02-PCR-LE	2	Extension cable for 2P05·3P05 2.8 m

[PCR2000LE 18 kVA example]

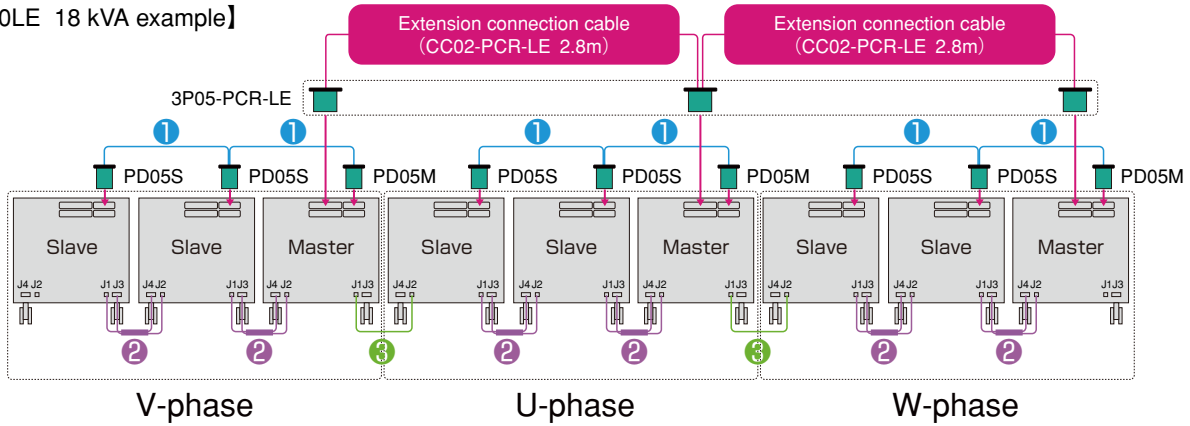

Accessories for three-phase driver and parallel operation driver

① Connecting cable (0.7m) ② Power signal cable (0.3m) ③ Power-sync cable (Accessories 1m) *equivalent to the LC01-PCR-LE

● Example of the combined system using different models

Capacity	Model	Qty	Part
15 kVA Parallel operation system	PCR2000LE	1	AC Power Supplies(2 kVA)
	PCR4000LE	1	AC Power Supplies(4 kVA)
	PCR9000LE	1	AC Power Supplies(9 kVA)
	PD05M-PCR-LE	1	Parallel operation driver (Master)
	PD05S-PCR-LE	2	Parallel operation driver (Slave)
	PC01-PCR-LE	1	Extension connection cable (for parallel operation) 1.3 m
	CC11-PCR-LE	2	Extension power signal cable (for parallel operation) 1 m

Capacity	Model	Qty	Part
11.5 kVA Three phases expended system	PCR500LE	1	AC Power Supplies(500 VA)
	PCR2000LE	1	AC Power Supplies(2 kVA)
	PCR9000LE	1	AC Power Supplies(9 kVA)
	3P05-PCR-LE	1	Three-phase output driver
	CC01-PCR-LE	2	Extension cable for 2P05·3P05 1.5 m

[Example of 3 different-model units in parallel]

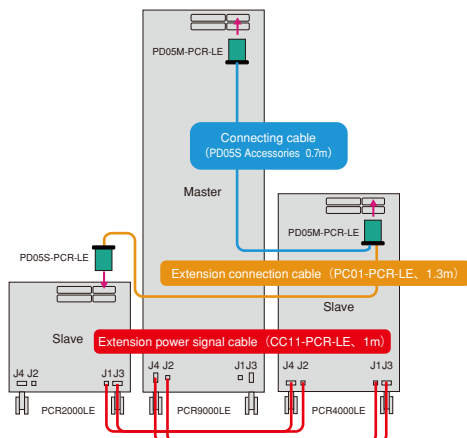

[Example of the three-phase unbalanced system]

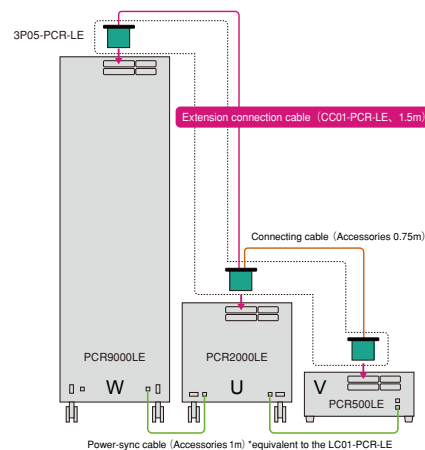

* When the "POWER SELECTOR" of the unit for the "V-phase" is switched to the "Master unit", and the unit for the "U-phase" and the "W-phase" is switched to the "Slave unit".

applications

■ For testing of the Smart Grid related applications

● Power conditioner (DUT)

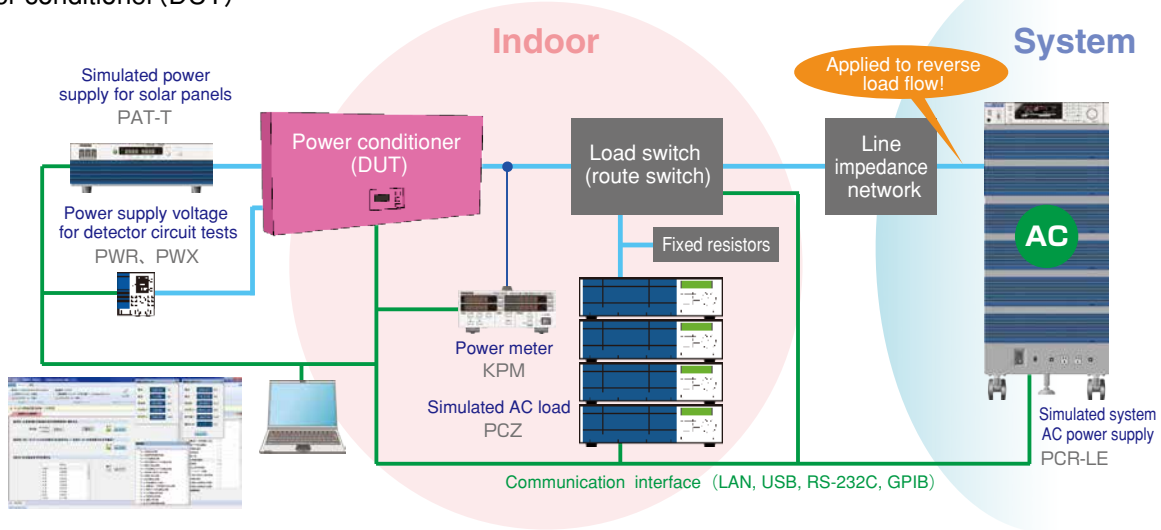

● Storage Battery for Residential use (DUT)

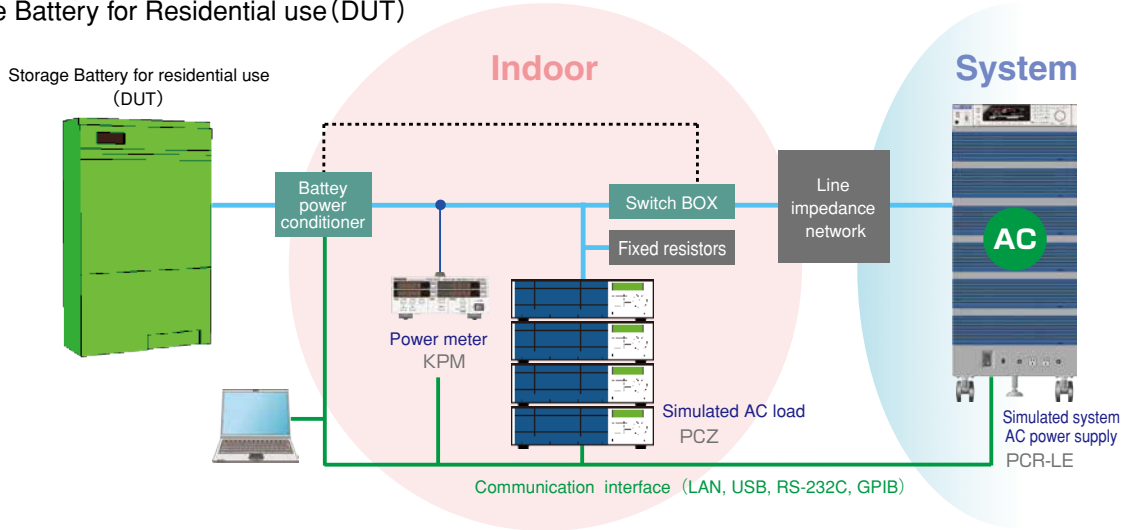

● EV charge and discharge station (DUT)

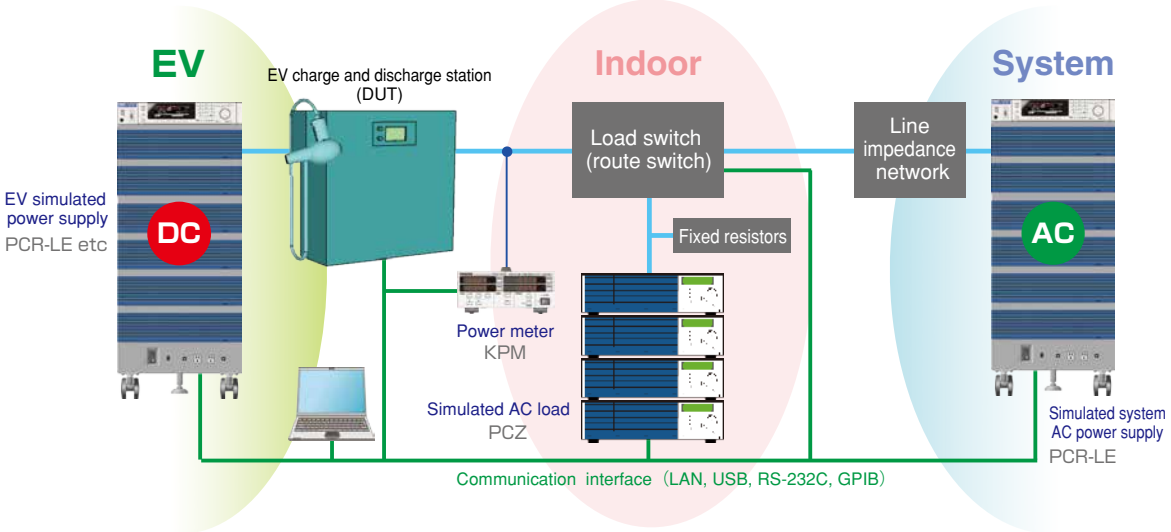

■ For testing of the Smart Grid related applications

● Smart meter (DUT)

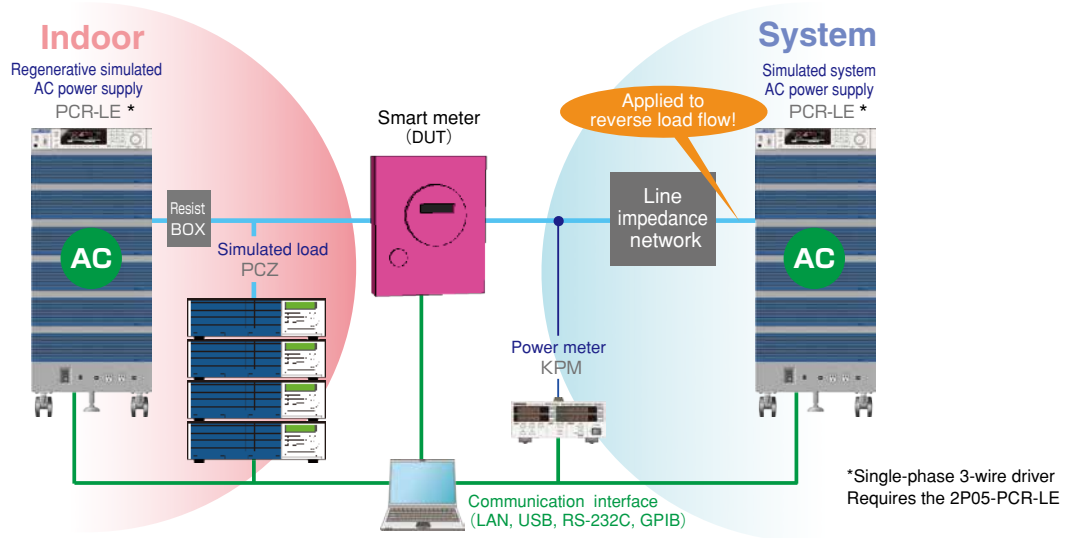

● Heat pump (DUT)

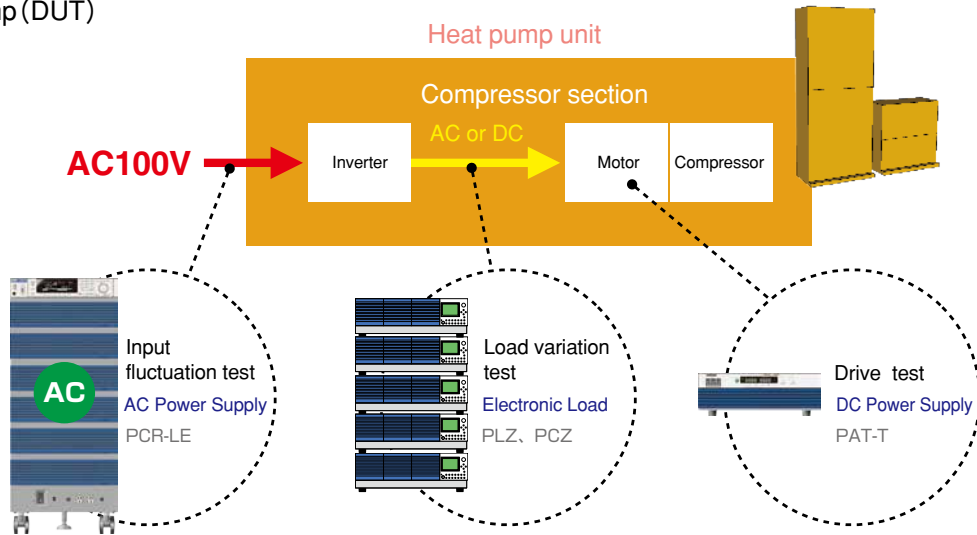

Use as a simulated load for a power conditioner grid connection test system.



AC Electronic Load
PCZ1000A

- Maximum input load power: 1000 W
- Input voltage range: 14 V to 280 V(rms)
- Input current range: 0 A to 10 A(rms)
- Input frequency range: 45 Hz to 65 Hz
- Equipped with constant current, constant resistance, and constant power modes.
- Parallel operation function (Max. 5 units, up to 5 kW/50 A rms)
- Equipped with tracking operation function
- Crest factor function
- RS-232C equipped as a standard
- Application software(option)

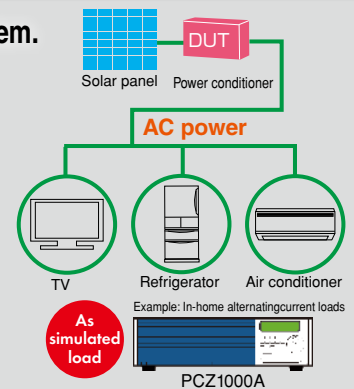

applications

■ For Standard Compliance testing

● Single phase system

● Three phase system

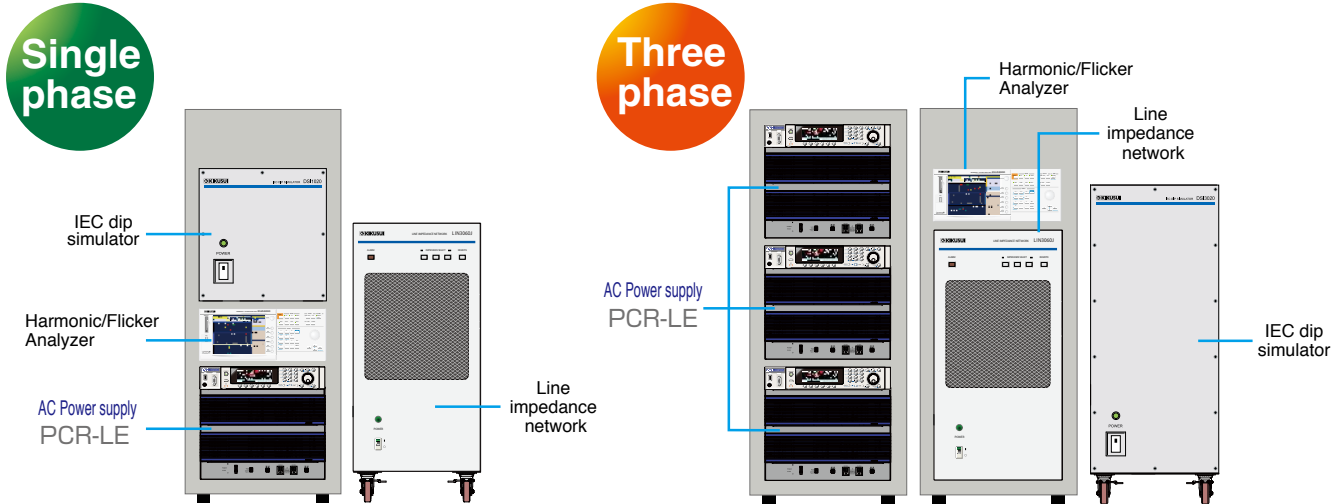

This system can simulate various conditions of phenomena occurring in AC power environments. It can be used for immunity tests of electrical and electronic devices which are connected to a low-voltage distribution system, or which have DC power input ports, under the standard conditions as specified on the right. The test conditions can be set outside the standard range, allowing the system to be used for preliminary tests prior to standard tests, immunity margin tests, and stress tests. The KHA3000 harmonic/flicker analyzer combines a PCR-LE Series AC power supply, LIN Series line impedance network, and application software*, allowing tests which conform to IEC standards and JIS standards.

*SD009-PCR-LE [Quick Immunity Sequencer 2] is required. (See P. 16.)

- IEC61000-4-11..... Voltage dipping, instantaneous power failure and voltage variation
- IEC61000-4-13..... Higher harmonics wave/interharmonic wave
- IEC61000-4-14..... Voltage swing
- IEC61000-4-27..... Unbalance in units
- IEC61000-4-28..... Variation in power supply frequency for units with 16 A/phase
- IEC61000-4-34..... Voltage drop (dip), instantaneous power failure and voltage variation for units with input current exceeding 16 A/phase
- IEC61000-4-17..... Ripple at the DC input power terminal
- IEC61000-4-29..... Voltage drop (dip), instantaneous power failure and voltage variation in DC
- IEC61000-3-2,12..... Harmonic electric current limit level
- IEC61000-3-3,11..... Voltage fluctuation, Flicka limit level

■ For testing of the EV charging system

● EV charging system (Item under test)

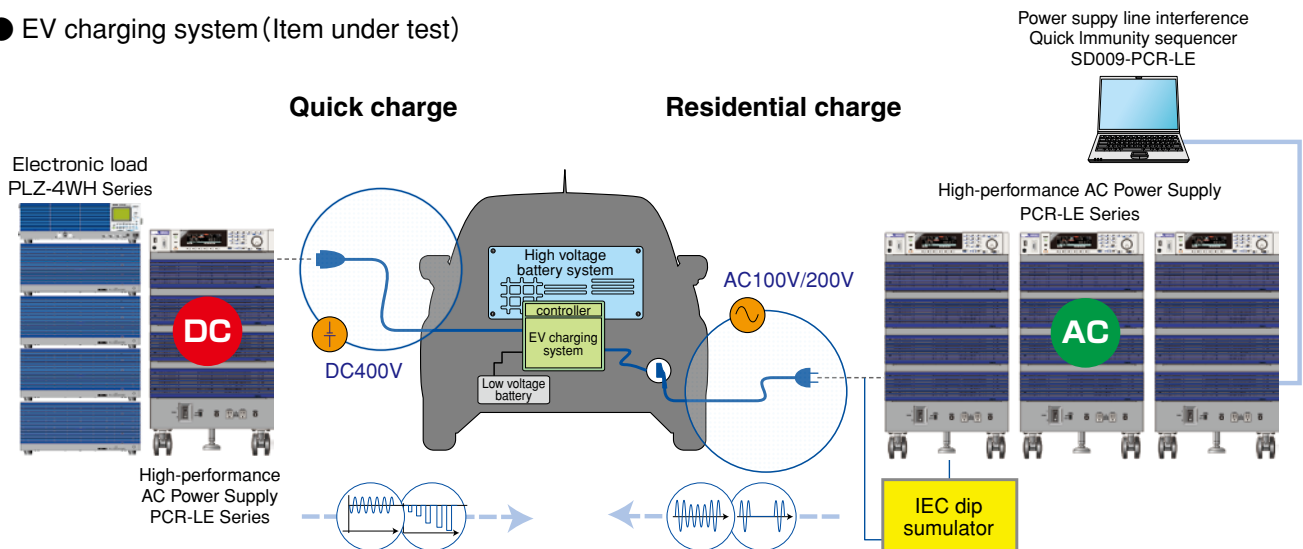

IEC Dip·Simulator DSI Series [DSI1020/DSI3020]



◀ DSI3020

For the Voltage dips, short interruptions and voltage variations immunity test system, complied to the IEC61000-4-11 (2004)

The DSI Series is an option unit used to configure the test system complying with the "Voltage Dips, Short Interruptions and Voltage Variations Immunity Tests" as defined in the IEC61000-4-11 (2004) standard. It can be used in combination with the Kikusui AC power supplies (PCR-LE/LE2 series). It meets the test requirement of : high-speed voltage switching (rise time: 1 μ s to 5 μ s), voltage dips (0 %, 40 %, 70 %, and 80 %), and phase-voltage and line-voltage tests.

- DSI1020 : Applied to the Single-phase two-wire system
- DSI3020 : Applied to the Single-phase two-wire, Single-phase three-wire, Three-phase three-wire, and Three-phase four-wire system.

- ▶ Fast Voltage rise/fall time (1 μ s to 5 μ s)
- ▶ Applied to the voltage dips (0 %, 40 %, 70 %, and 80 %)
- ▶ Applied to the Line Voltage-dip* and the Phase Voltage-dip
- ▶ Maximum Line Input voltage 500 V (rms)

*The Line Voltage-dip applied to only the "DSI3020".

When connecting the DSI Series with the PCR-LE Series, the output capacity of the AC power supply of each phase will be limited. For details, please refer to the individual product brochure or ask for the local distributor.

Model	Maximum current (per phase)	Wiring configuration		DIP level	Complied standard	Remarks
		Single phase	Three phase			
DSI1020	20 A	○	—	0/40/70/80 %	IEC61000-4-11 (2004)	For Single Phase only
DSI3020	20 A	○	○	0/40/70/80 %	IEC61000-4-11 (2004)	For Single Phase or Three Phase

Line Impedance Network

LIN Series [LIN1020JF/LIN3020JF/LIN3060J/OP01-LIN1020JF]

It is equipped with the IEC/JIS/JET standard impedance. It supports voltage fluctuation and flicker tests.

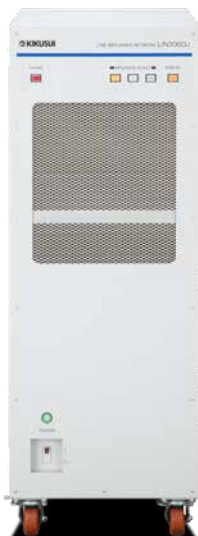

◀ LIN3060J

■ LIN1020JF

LIN1020JF is equipped with the impedance determined by the IEC flicker test (IEC61000-3-3) and JIS harmonics (JIS C61000-3-2), which can be configured via the USB interface (standard feature) or the contact signal interface from the application software. The single-phase two-wire IEC flicker/harmonics test system can be configured in combination with AC power supply PCR-LE/LE2 and harmonic flicker analyzer KHA1000/KHA3000.

■ LIN3020JF

LIN3020JF is equipped with the impedance determined by the IEC flicker test (IEC61000-3-3) and JIS harmonics (JIS C61000-3-2), which can be configured via the USB interface (standard feature) or the contact signal interface from the application software. The single-phase two-wire/three-wire/three-phase IEC flicker/harmonics test systems can be configured in combination with AC power supply PCR-LE/LE2 and harmonics flicker analyzer KHA1000/KHA3000.

■ OP01-LIN1020JF

OP01-LIN1020JF is an additional unit that is used to expand LIN1020JF in three phases (addition of V phase and W phase).

■ LIN3060J

LIN3060J is equipped with the impedance established in the JIS/JET standard that is required in the test for the grid-connected power conditioner. This is the standard impedance unit that is indispensable to the construction of the system for the grid connection test of JETGR0002-1-2.0.

* Note that this is not applicable to the IEC flicker test. Contact us for a product that is compliant with IEC61000-3-11.

Model	Maximum current (per phase)	Wiring configuration	Complied standard			Remarks
			IEC 61000-3-3 230 V 50Hz	JIS C61000-3-2 *1 JET GR0002-1-3.0		
				100 V 50/60 Hz	200 V 50/60 Hz	
LIN1020JF	20 A	Single phase 2-wire	○	○	○	Product for IEC flicker / voltage fluctuation test *1 Insertion of the impedance is optional in the JIS harmonics test. (Normally applied for bypass.) *2 OP01-LIN1020JF does not work solely.
LIN3020JF		Single phase 2-wire/3-wire Three phase 3-wire/4-wire	○	○	○	
LIN1020JF + OP01-LIN1020JF *2		Single phase 2-wire/3-wire Three phase 3-wire/4-wire	○	○	○	
LIN3060J	60 A	Single phase 2-wire/3-wire Three phase 3-wire/4-wire	—	○	○	JIS/JET standard Product for grid connection test
Impedance Value	Single phase 2-wire		0.4 Ω +Jn0.25 Ω (Z3)	0.4 Ω +0.37 mH(Z1)	0.38 Ω +0.46 mH(Z2)	
	Single phase 3-wire		0.24 Ω +Jn0.15 Ω	0.19 Ω +0.23 mH	0.19 Ω +0.23 mH	
	Three phase 3-wire Three phase 4-wire		(0.16 Ω +Jn0.1 Ω for N phase)	(0.21 Ω +Jn0.14 mH for N phase)	(0.19 Ω +Jn0.23 mH for N phase)	

options

[Caution] For customers using the former PCR-L/LA Series

Please be aware that the PCR-LE Series is not interchangeable with the former PCR-L/LA Series of products. Therefore it is not possible to upgrade a system with a combination of products from the two different series'. In general (with some exceptions) the options from one series cannot be used in the other. If there are any unclear points or for other details, please contact a Kikusui sales office.

Application software

* For details, please see the Kikusui homepage.



Power Line Disturbance Immunity Testing Software

SD009-PCR-LE [Quick Immunity Sequencer 2]

List of conformance to the EMC standard tests

○ : Conforming as standard
 △ : Partially non-conforming
 — : Function not available

Standard	Item	Conforming	
		Single-phase	Three-phase
IEC61000-4-11	Voltage drop (dip)	○	○
	Voltage dipping, instantaneous power failure and voltage variation	○	○
	Over swing	○	○
	Flat curve	○	○
IEC61000-4-13	Higher harmonics wave/interharmonic wave	○	○
	Odd harmonics the order of which is not a multiple of 3	○	○
	Odd harmonics the order of which is a multiple of 3	○	○
	Even harmonics	○	○
	Interharmonics	○	○
IEC61000-4-14	Voltage swing	○	○
	Interval	○	○
IEC61000-4-17	Single-phase rectifier circuit	○	—
	Three-phase rectifier circuit	○	—
IEC61000-4-27	Unbalance in units	—	△*1
IEC61000-4-28	Variation in power supply frequency for units with 16 A/phase	○	○
	Frequency variation	○	○
IEC61000-4-29	Voltage drop (dip)	○	—
	Voltage drop (dip), instantaneous power failure and voltage variation in DC	△	—
	Voltage variation	○	—
IEC61000-4-34	Voltage drop (dip)	△*2	△*2
	Voltage drop (dip), instantaneous power failure and voltage variation for units with input current exceeding 16 A/phase	△*2	△*2
	Voltage variation	○	○

*Immunity testing for units with 16 A/phase except for those required by IEC61000-4-34
 *1 Capability of rapid change with 1 μs to 5 μs is required for 110 %, 95.2 %, 93.5 %, 90 %, 87 %, 80 %, 74 %, 71 %, 66 %
 Preliminary test is capable since the voltage response of the PCR-LE/LE2 is 20 μs in FAST mode and 30 μs in MEDIUM mode.
 *2 The device between the range of 16A to 75A requires to have the capability of rapid change with 1μs to 5μs.
 The device exceeding 75A does not require to have the capability of rapid change with 1μs to 5μs.
 (It is relaxed to 1 μs to 50 μs for the device exceeding 75 A.)

The latest standards for IEC61000-4 supported!

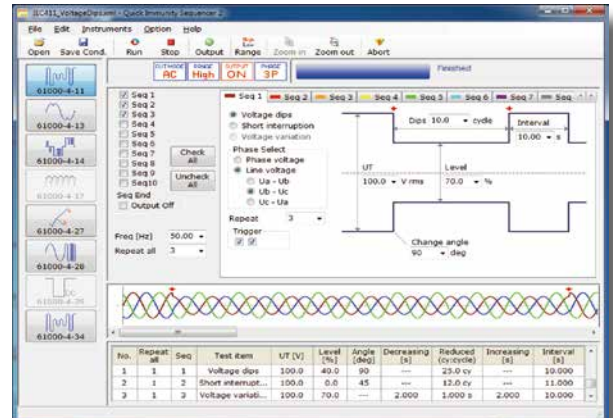

"Quick Immunity Sequencer 2" (model name: SD009-PCR-LE) is an application software for immunity testing with the AC power supply PCR-LE series system, based on the power line disturbance standard (IEC61000-4 Series) for the immunity testing of the EMC standard. Not only can it be used for compliance testing based on the latest standards or for some types of preliminary testing, but the software can be also employed for advance checking in development phases and for immunity margin tests, because it allows extended testing conditions to be set as needed.



Remote control software for the Windows tablet

SD021-PCR-LE [RMT CONT SOFTWARE FOR PCR-LE]

The Windows tablet can be used as a remote controller !

The SD021-PCR-LE is the software that can control the PCR-LE/LE2 Series. It is capable to change the setting condition of the "wiring method", "output mode", "voltage range", "voltage value", and "frequency value". And these settings changed by the remote controller can be saved and recalled. Moreover, it can display the measurement value of the AC power supply. The remote operation and control of the AC power supply from the distance can be easily realized.

- Operating Environment : Intel Core 2 or later / Windows 8.1 / Memory 4GB / Storage 128GB / Display resolution 133 x 768 or higher / USB port
- *The LAN cable, LAN adaptor (micro USB to the wired LAN), the optional LAN board (LN05-PCR-LE) are required.

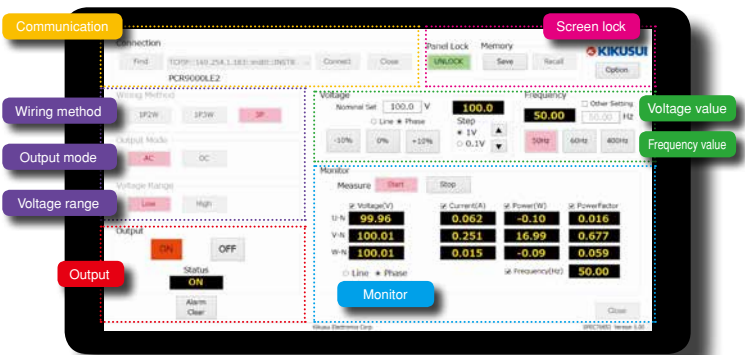

Screen display (main screen)

Application software



“Wavy” sequence creation software

SD011-PCR-LE [Wavy for PCR-LE]

Trial version is available on our web!!

<http://www.kikusui.co.jp/en/download/index.html>

Download!

The software extends the feature of waveform generation and sequence functions. Easy sequence control without programming knowledge.

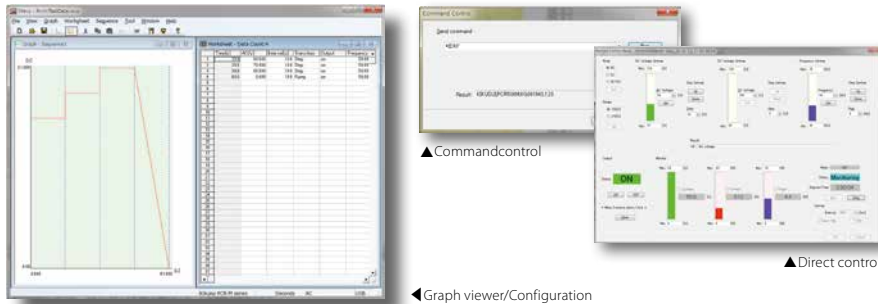

Wavy is an application software that supports sequence creation and the operation for Kikusui power supplies and electronic loads.

Wavy allows you to create and edit sequences visually with a mouse without programming knowledge. Real-time monitor function is added to the Ver. 4.0 or later, that enables monitoring and logging values of voltage and current. The Ver.5.0 equips Remote Control Panel function that enables you to control power supplies as if you were using a remote controller.

- It makes you easier to create or edit the test condition file required for the sequence operation.
- By using the storage function of test condition data file, it enables you to manage the test condition of the standard routine test.
- The progress of execution sequence will be displayed on the "practical dialogue" with the setting value and the cursor.
- It is possible to observe the intuitionistic output through by the "monitor graph" that plots the ongoing monitor value.
- You can save the acquired monitor data as a test result.
- Added the "waveform image" window. You can easily keep track of the AC signal.
- Allows you to edit and create the new arbitrary waveform easily. You can instantly write then output the created arbitrary waveform.
- Supports the status of description of sequence step for "selected" or "not selected". It enables you to select depends on the requirement such as the "pausing function", "trigger function", or "AC waveform".
- Newly added features of "Sequence Pre-view Dialog" enables you to confirm the waveform before executing the sequence operation.



Avionics Test Software

SD012-PCR-LE

Supporting to the compliance testing of the avionics test standard. The test pattern can be conducted from the Library.

Supported Standards

- Military Standard:**MIL-STD-704A/E/F
- Civilian Standard:**RTCA DO-160F/G
- Civilian Standard:**JIS W0812:2004

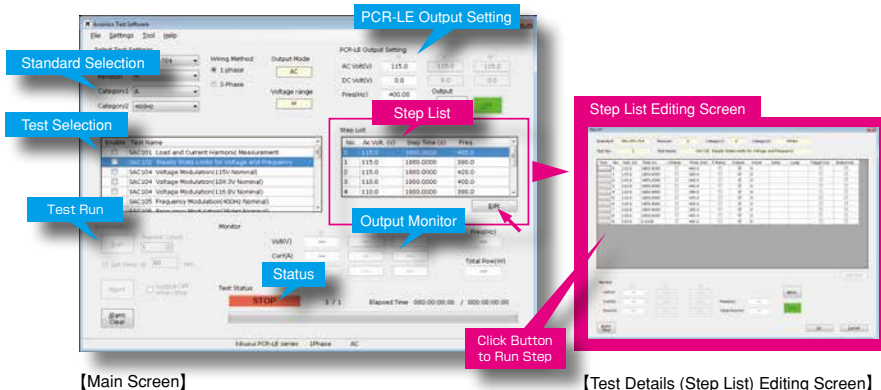

Test standards have been established that electrical components and parts installed on aircraft must meet. All electrical components and parts installed on the fuselage must comply with these standards, but the applicable test standards vary according to the intended use and purpose. Test standards can be largely divided into two types: military standards and civilian standards. In addition, aircraft manufacturers sometimes apply their own set of private standards. Avionics Test Software [SD012-PCR-LE] is a software application that support to the aircraft test standards, and is used to control the PCR-LE/LE2 Series that enables you to conduct the test standards for the MIL-STD-704, RTCA/DO-160 and JIS W0812 standards. Test patterns are library-based, which enables tests to be easily run by simply selecting the wiring configuration and the type of test. In general, the 400 Hz AC power supply is used for the large aircraft, and the 28 VDC power supply is used for the small aircraft.

- Easy configuration - just select standard from library
- Test step editing and saving - convenient for development and evaluation required with marginal testing
- Test condition reporting function - enables test history logging
- Remote control via LAN

options

Interface boards * Any one of the following can be installed. * **LE2** indicates the available option for the multi-output models, "PCR-LE2 Series".



GPIB Interface **LE2**

IB05-PCR-LE

USB Interface **LE2**

US05-PCR-LE

LAN Interface (LXI) **LE2**

LN05-PCR-LE

Analog signal interface boards

* Any one of the following can be installed.

* **LE2** indicates the available option for the multi-output models, "PCR-LE2 Series".



EX05-PCR-LE

EX05-PCR-LE (An Amplifier type) **LE2**

Amplifies the input waveform without changing it. By using this interface board, you can control the PCR-LE with an external contact for (output ON/OFF, sequence start/stop, alarm clear, forced power OFF) and operation status monitoring (output status, alarm status, busy status, current peak limit and overload status).

Note: If the input waveform will be amplified and used in a multi-phase system, one of these interface board is required for each phase. PCR6000LE2 and PCR9000LE2 cannot amplify the input waveform in multi-phase output mode.



EX06-PCR-LE

EX06-PCR-LE (Amplitude control type) **LE2**

The output AC voltage value can be varied according to the input voltage signal. By using this interface board, you can control the PCR-LE with an external contact for (output ON/OFF, sequence start/stop, alarm clear, forced power OFF) and operation status monitoring (output status, alarm status, busy status, current peak limit and overload status).

EXT-DC mode

The input waveform is directly amplified and output.

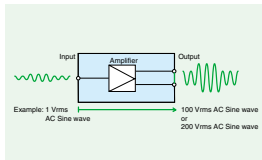

Voltage amplification rate: 100-times or 200-times

Model	Output Wirings	Required Quantity	PCR-LE Series	PCR-LE2 Series
EX05-PCR-LE	Single-phase two-wire	1	PCR-LE Series	PCR-LE2 Series
	Single-phase three-wire	2	U-phase, V-phase	U-phase, V-phase *
	Single-phase three-wire /four-wire	3	U-phase, V-phase, W-phase	U-phase, V-phase, W-phase *
EX06-PCR-LE	Single-phase two-wire	1	PCR-LE Series	PCR-LE2 Series
	Single-phase three-wire /four-wire	1	U-phase	U-phase

*The PCR6000LE2 and PCR9000LE2 do not have a feature to amplitude the input waveform in the multiple output mode.

EXT-AC mode

The voltage of the output alternating current can be changed based on the level input DC signal.

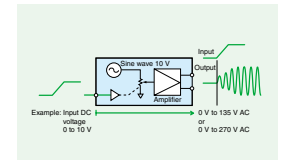

Voltage amplification rate: 13.5-times or 27-times

Input power cord/Power-sync cable

* **LE2** indicates the available option for the multi-output models, "PCR-LE2 Series".

For PCR1000LE

3-core cable 5.5 mm²/3 m M4

AC5.5-3P3M-M4C

For PCR2000LE

3 single-core cables 8 mm²/3 m M5

AC8-1P3M-M5C-3S

For PCR3000LE/PCR6000LE/PCR6000LE2 **LE2**

3 single-core cables 14 mm²/3 m M8

AC14-1P3M-M8C-3S

For PCR4000LE

3 single-core cables 22 mm²/3 m M8

AC22-1P3M-M8C-3S

For PCR9000LE/PCR9000LE2 **LE2**

4 single-core cables 14 mm²/3 m M5

AC14-1P3M-M5C-4S

Power-sync cable, 1 m

Multiple units of the PCR-LE Series can be connected and turned ON/OFF.

LC01-PCR-LE

Control panel cable

* **LE2** indicates the available option for the multi-output models, "PCR-LE2 Series".

Extension cable for control panel **LE2**

EC05-PCR (cable's length: 2 m)

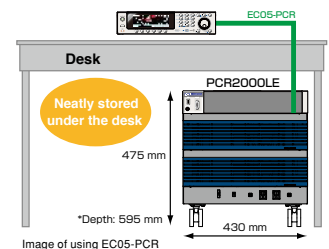

Parallel operation driver



Note: When using this product, a PCR-LE Series unit with firmware version 3.01 or later is required.

If the firmware of your product is 1.X or earlier, modifications and other changes will be required. Please consult with your local distributor. This option cannot be used with PCR500LE or PCR1000LE.

Parallel operation driver (Master)

PD05M-PCR-LE

Parallel operation driver (Slave)

PD05S-PCR-LE

Accessories: Connecting cable (0.7 m), Power signal cable (0.3 m)



Extension cable

This extension cable is used if the provided connection cable (0.7 m) or power signal cable is too short when the master unit layout is changed or when connecting different models together.

Extension connection cable (1.3 m) **PC01-PCR-LE**

Extension power signal cable (1 m) **CC11-PCR-LE**

Single-phase 3-wire output /Three-phase output driver

* A single-phase 3-wire output driver and three-phase operation output driver cannot be used in combination.



Note: When using this product, the PCR-LE Series unit with firmware version 2.0 or later is required.

If the firmware of your product is 1.X or earlier, modifications and other changes will be required. Please consult with your local distributor.

Single-phase 3-wire output driver

2P05-PCR-LE

Accessories : Connecting cable (0.75m), Power-sync cable (LC01-PCR-LE, 1 m)

Three-phase output driver/Three-phase output driver (500 Hz limit type)

3P05-PCR-LE/3P05-PCR-LE (500Hz LMT)

Accessories: Connecting cable (0.75 m)×2, Power-sync cable (LC01-PCR-LE, 1 m) ×2



Extension cable

This extension cable is used if the provided connection cable (0.75 m) is too short when connecting different models together or when using the parallel operation driver.

Extension connection cable (1.5 m) **CC01-PCR-LE**

Extension connection cable (2.8 m) **CC02-PCR-LE**

Rack mount/Prodout about standard

For PCR500LE Brackets

KRB4 (For EIA inch size)

KRB200 (For JIS metric size)

For PCR1000LE Brackets

KRB6 (For EIA inch size)

KRB300 (For JIS metric size)

For PCR2000LE Brackets

KRB9 (For EIA inch size)

KRB400 (For JIS metric size)

Base holding angle

OP03-KRC

Residual charge measurement

SPEC40414A

This unit is applied to the residual charge measurement in conformance with the Electric Appliance Safety Law, IEC60950-1, IEC60335-1, IEC60065, and other regulations.

It allows residual charge to be measured easily and accurately without unplugging work.

exterior design

■ Front panel

PCR500LE

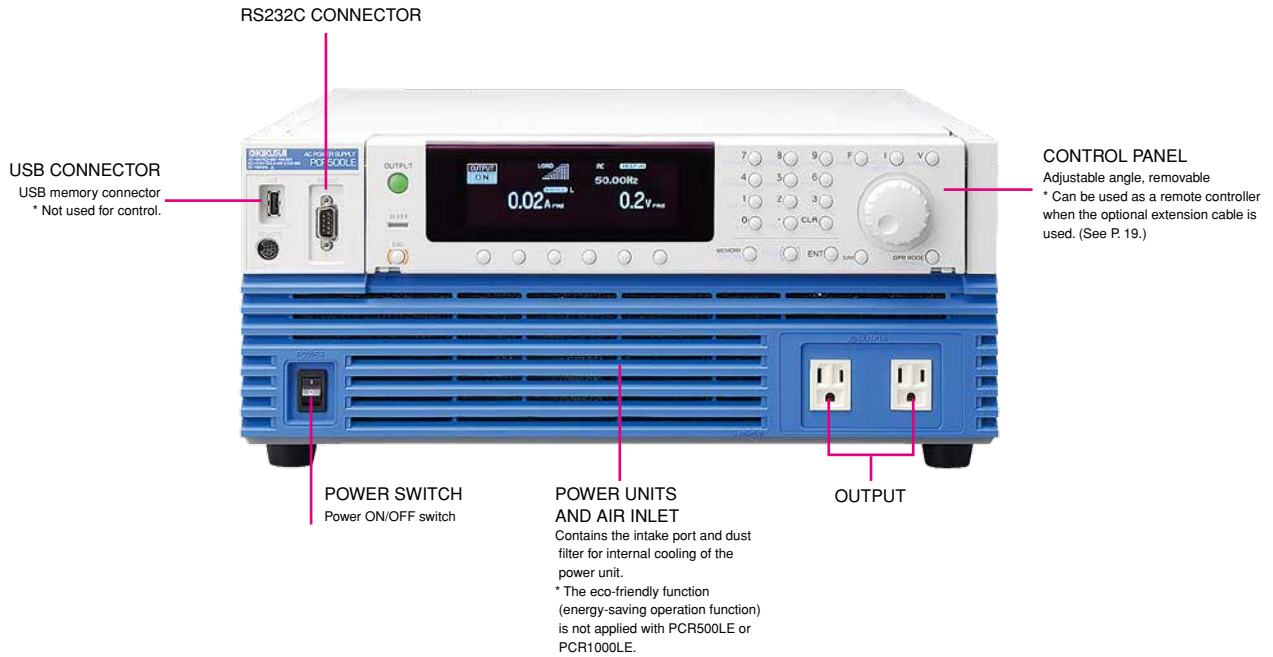

PCR2000LE

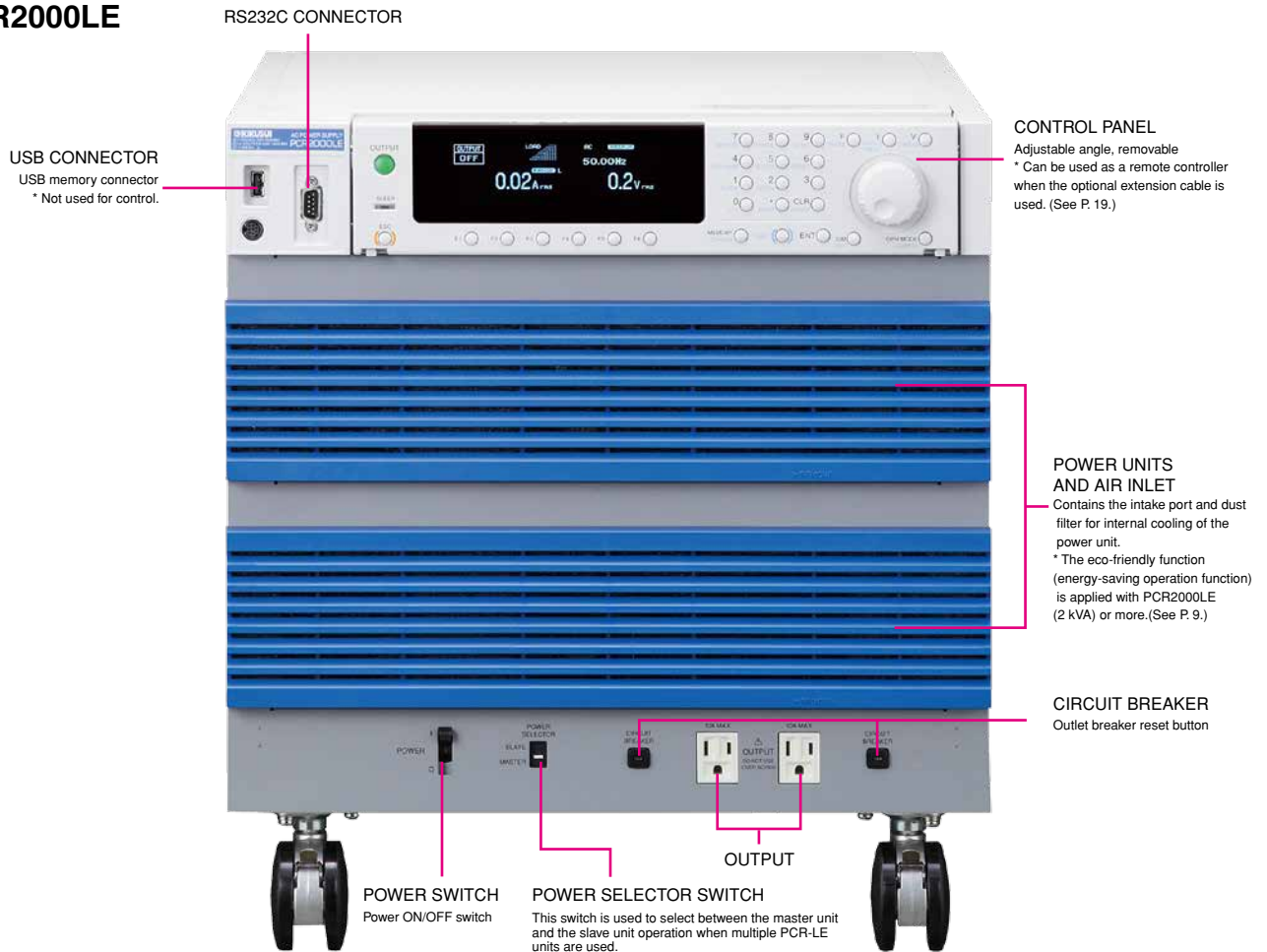

Rear panel

PCR500LE

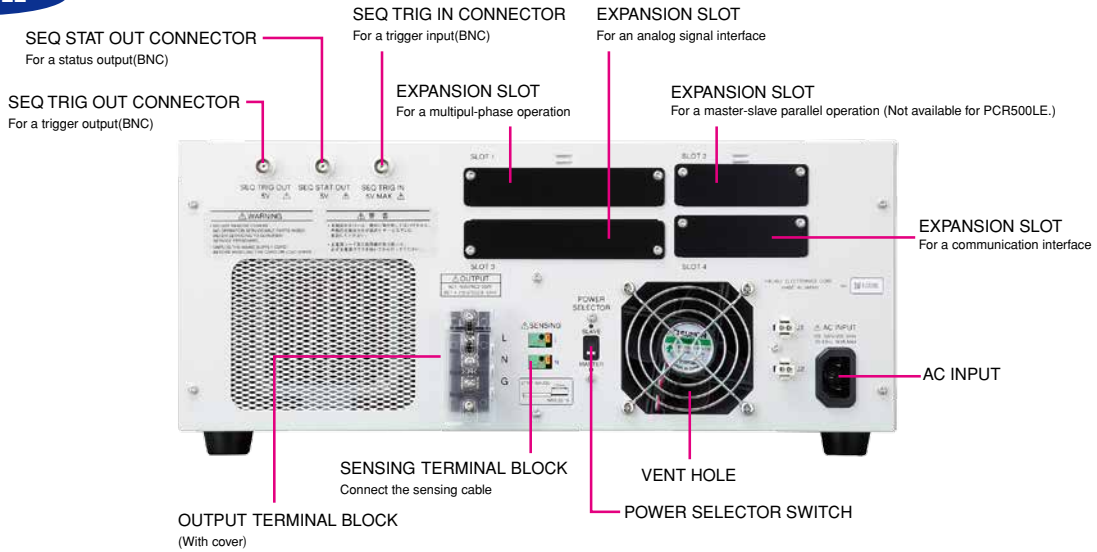

PCR1000LE

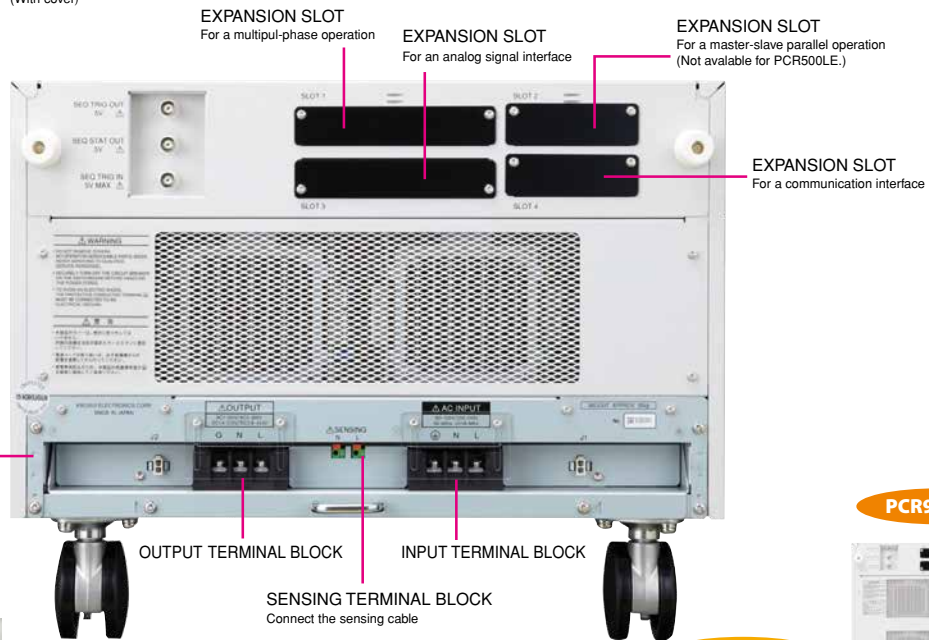

Input/output terminal block tray
(Excluding the PCR500LE)
Slide-out structure allows wiring easily.



Photo: PCR1000LE

PCR9000LE



PCR6000LE



PCR3000LE



PCR4000LE



PCR2000LE

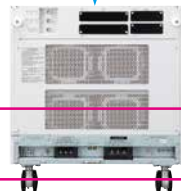

*In case the terminal block tray is not returned to the position in the storage compartment, the PCR-LE can not be operated even if the power switch is turned on.

dimensions

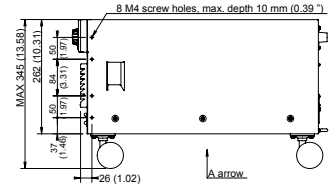
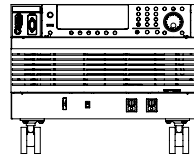
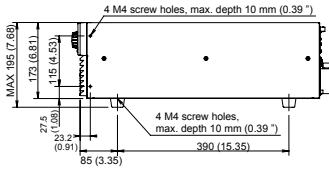
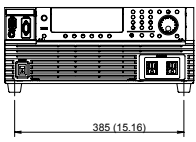
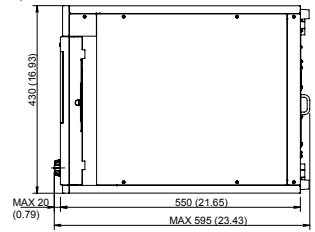
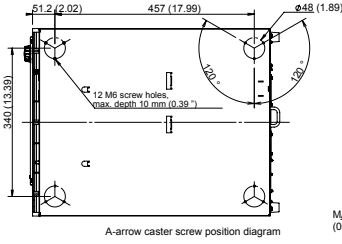
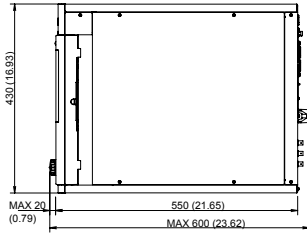

PCR500LE

PCR1000LE

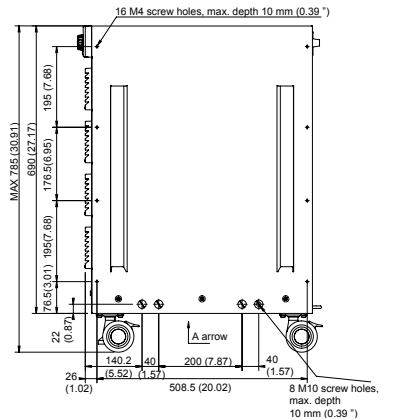
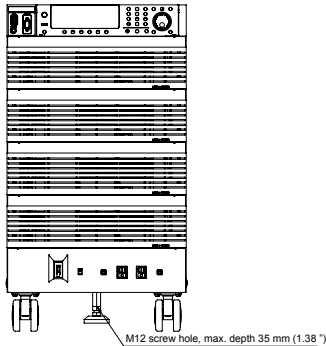
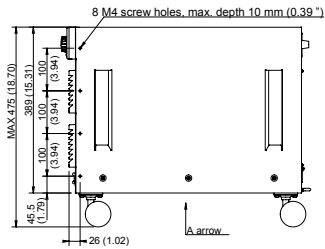
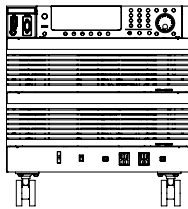
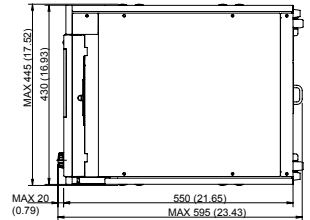
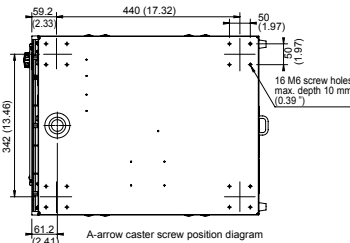
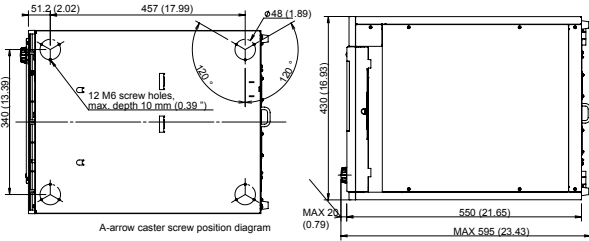

PCR2000LE

PCR3000LE

PCR4000LE

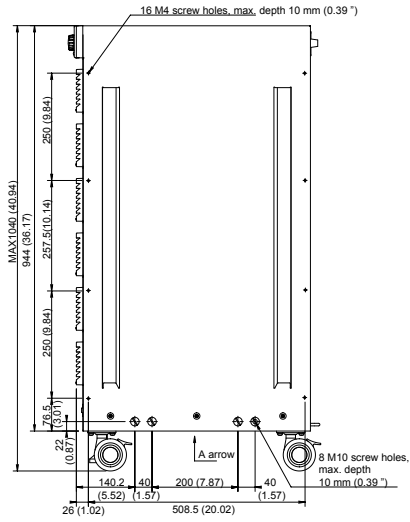
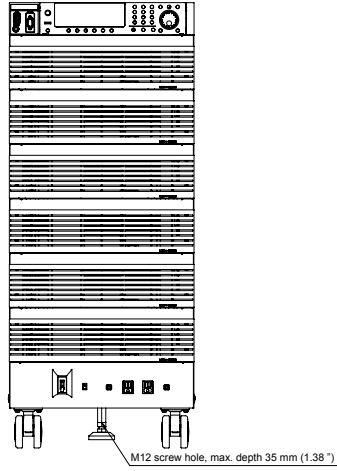
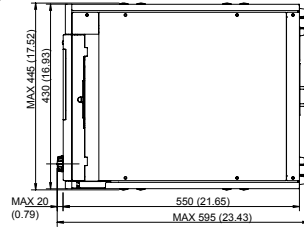
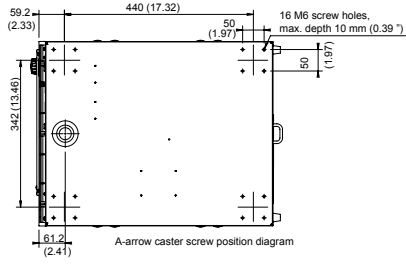

PCR6000LE

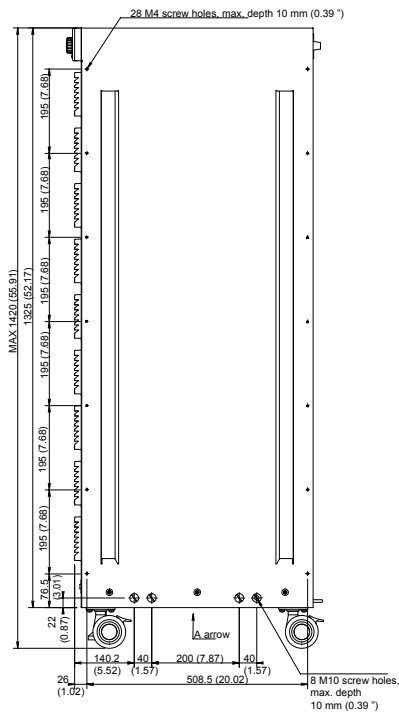
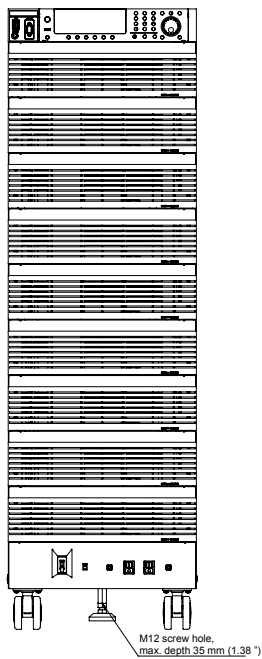
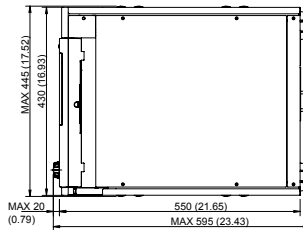
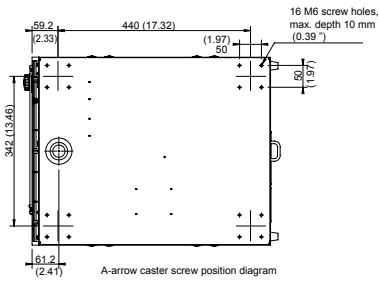

PCR9000LE

specifications

Item/Model	PCR500LE	PCR1000LE	PCR2000LE	PCR3000LE	PCR4000LE	PCR6000LE			PCR9000LE					
Input ratings (AC rms)	1P2W					3P3W200V			3P4W400V		3P3W200V		3P4W400V	
Voltage	85 V to 132 V/170 V to 250 V *1					170 V to 250 V			Line voltage 324 V to 440 V (Phase voltage 187 V to 254 V)		170 V to 250 V		Line voltage 324 V to 440 V (Phase voltage 187 V to 254 V)	
Phases	Single phase					Three phase 3-wires			Three phase 4-wires		Three phase 3-wires		Three phase 4-wires	
Frequency	47Hz to 63Hz													
Apparent power	Approx. 0.93 kVA	Approx. 1.8 kVA	Approx. 3.6 kVA	Approx. 5.5 kVA	Approx. 7.3 kVA	Approx. 10.6 kVA			Approx. 15.7 kVA					
Power factor *2	0.97 (TYP)													
Max. current *1	11.3 A, 5.5 A	22 A, 10.8 A	44 A, 21.5 A	66 A, 32 A	88 A, 43 A	64 A	38 A	21 A	55 A	30 A				
AC mode output ratings (AC rms)														
Voltage (output L range, output H range)	1 V to 150 V / 2 V to 300 V													
Resolution	0.1V													
Voltage setting range	0V to 152.5V / 0V to 305.0V													
Voltage setting accuracy (output L range, output H range) *3	± (0.3 % of set + 0.6 V)													
Max. current (output L range, output H range) *4	5 A, 2.5 A	10 A, 5 A	20 A, 10 A	30 A, 15 A	40 A, 20 A	60 A, 30 A			90 A, 45 A					
Phase	Single phase													
Power capacity	500 VA	1 kVA	2 kVA	3 kVA	4 kVA	6 kVA			9 kVA					
Maximum peak current *5	Max. current (rms) × 4 (TYP)													
Max. reverse current *6	30 % of the max. current (rms)													
Load power factor	0 to 1 (leading or lagging) *4													
Frequency *4	1 Hz to 999.9 Hz													
Resolution	0.01 Hz (1.00 Hz to 100.0 Hz), 0.1 Hz (100.0 Hz to 999.9 Hz)													
DC mode output ratings														
Voltage	±1.4V to ±212V / ±2.8V to ±424V													
Resolution	0.1 V													
Voltage setting range	-215.0V to +215.5V / -431.0V to +431.0V													
Voltage setting accuracy (output L range, output H range) *7	± (0.05 % of set + 0.05/0.1 V)													
Max. current *8	3.5 A, 1.75 A	7 A, 3.5 A	14 A, 7 A	21 A, 10.5 A	28 A, 14 A	42 A, 21 A			63 A, 31.5 A					
Max. instantaneous current *9	Max. current (rms) × 3.6													
Power capacity	350 W	700 W	1.4 kW	2.1 kW	2.8 kW	4.2 kW			6.3 kW					
Output voltage stability														
Line regulation *10	Within ±0.1 %													
Load regulation (output L range, output H range) *11	Within ±0.1 V, within ±0.2 V													
Output frequency variation *12	FAST	Within ±0.2 %					-							
	MEDIUM	Within ±0.3 %												
Ripple noise in DC mode (5 Hz to 1 MHz components)	0.15 Vrms or less		0.2 Vrms or less			0.25 Vrms or less								
Ambient temperature variation *13	100 ppm/°C (TYP)													
Output frequency stability, output voltage waveform distortion ratio, output voltage response speed, efficiency														
Output frequency stability *14	Setting accuracy	Within ±5×10 ⁻³												
		Within ±1×10 ⁻⁴												
Output voltage waveform distortion ratio *15	FAST	±0.2 % or less					-							
	MEDIUM	±0.3 % or less												
Output voltage response speed *16	FAST	20 μs (TYP)					-							
	MEDIUM	30 μs (TYP)												
Efficiency *17	54 % or more, 56 % or more	55 % or more, 57 % or more					58 % or more							
Meters (fluorescent display)														
Voltmeter *18	Resolution	0.1 V												
	Accuracy	± (1 % of rdng + 2 digits) (10V to 424 V and at room temperature)												
Ammeter *18	Resolution	0.01 A					0.1 A							
	Resolution	± (1 % of rdng + 2 digits) (5 % of the max. rated current to max. rated current and at room temperature)												
Wattmeter *19	Resolution	0.1 W / 1W					1 W							
	Resolution	± (1 % of rdng +3 digits) (10 % of the rated power capacity to the rated power capacity, when the load power factor is 1, and at room temperature.)												

*1 100 V input type or 200 V input type

*2 When the input voltage is 100 V or 200 V, the output voltage is 100 V or 200 V, the output current is the rated value, the load power factor is 1, and the output frequency is between 40 Hz and 999.9 Hz.

*3 When the output frequency is between 45 Hz and 65 Hz, with no load, and at room temperature.

*4 When the maximum voltage is between 1 V and 100 V (L range) or 2 V and 200 V (H range) and the load power factor is between 0.8 and 1.

When the output voltage is between 100 V and 150 V (L range) or 200 V and 300 V (H range), the output current is reduced by the output voltage.

When the load power factor is between 0 and 0.8, the output current is reduced by the load power factor.

When the output frequency is between 1 Hz and 40 Hz, the output current is reduced by the output frequency.

*5 For capacitor-input rectifier loads (however, this is limited by the rated output current's rms value).

*6 When the output voltage is 100 V or 200 V and the output frequency is between 40 Hz and 999.9 Hz (reverse current is -180 deg out of phase with the output voltage).

*7 With no load at room temperature

*8 When the output voltage is between 100 V and 212 V (L range) or 200 V and 424 V (H range), the output current is reduced by the output voltage.

*9 Limited by the rated output current's rms value

*10 With respect to changes in the rated range

*11 With respect to 0 % to 100 % changes in the rating

When the output voltage is between 80 V and 150 V (L range) or 160 V and 300 V (H range) and the load power factor is 1. At the output terminal block. When the response mode is set to FAST or MEDIUM.

*12 Between 40 Hz and 999.9 Hz.

When the output voltage is between 80 V and 150 V (L range) or 160 V and 300 V (H range) and the load power factor is 1. This is the output line regulation with 200 Hz as the reference.

*13 With respect to changes in the rated range

When the output voltage range is 100 V or 200 V and the output current is 0 A.

*14 With respect to changes in all rated ranges

*15 When the output voltage is between 80 V and 150 V (L range) or 160 V and 300 V (H range) and the load power factor is 1.

*16 When the output voltage is 100 V or 200 V, the load power factor is 1, and the output current changes from 0 A to the rated value and from the rated value to 0 A.

*17 When the input voltage is 100 V or 200 V, the output voltage is 100 V or 200 V, the output current is the rated value, the load power factor is 1, and the output frequency is between 40 Hz and 999.9 Hz.

*18 With the true rms display, a waveform with a crest factor of 3 or less, DC, output frequency between 40 Hz and 999.9 Hz, RMS, and AVE.

*19 When the output frequency is between 45 Hz and 65 Hz.

Item/Model	PCR500LE	PCR1000LE	PCR2000LE	PCR3000LE	PCR4000LE	PCR6000LE			PCR9000LE		
BNC terminals	1P2W					3P3W200V	3P4W400V	3P3W200V	3P4W400V		
SEQ TRIG OUT *1	Pulse width approx. 10μs, open collector output, pullup at +5 V and approx. 10 kΩ serial resistance approx. 220 Ω, maximum sink current 10 mA, BNC connector										
SEQ STAT OUT *1	Step time output, open collector output, pullup at +5 V and approx. 10 kΩ serial resistance approx. 220 Ω, maximum sink current 10 mA, BNC connector										
SEQ TRIG IN *1	Operating pulse width 10μs or greater, photo-coupler input, driving voltage 5 V, serial resistance approx. 470 Ω, active with 7 mA source, BNC connector										
Limit Values and Protection Functions											
Voltage	AC voltage upper limit	0.0 V to 305.0 V									
	AC voltage lower limit	0.0 V to 305.0 V									
	DC voltage upper limit	-431.0 V to +431.0 V									
	DC voltage lower limit	-431.0 V to +431.0 V									
	Output overvoltage protection AC/AC+DC mode	0.0 V to 474.1 V									
	Output overvoltage protection DC mode	-474.1 V to +474.1 V									
	Output undervoltage protection AC/AC+DC mode	0.0 V to 474.1 V									
Output undervoltage protection DC mode	-474.1 V to +474.1 V										
Resolution	0.1 V										
Frequency	Upper limit	1 Hz to 999.9 Hz *2									
	Lower limit	1 Hz to 999.9 Hz *2									
	Resolution	0.01 Hz (1.00 Hz to 100.0 Hz), 0.1 Hz (100.0 Hz to 999.9 Hz)									
Current	Current limit*3 AC mode	0.50 A to 5.50 A	1.00 A to 11.00 A	2.00 A to 22.00 A	3.00 A to 33.00 A	4.00 A to 44.00 A	6.00 A to 66.00 A	6.00 A to 66.00 A	9.00 A to 99.00 A	9.00 A to 99.00 A	
	Current limit*3 DC/AC+DC mode	0.35 A to 3.85 A	0.70 A to 7.70 A	1.40 A to 15.40 A	2.10 A to 23.10 A	2.80 A to 30.80 A	4.20 A to 46.20 A	4.20 A to 46.20 A	6.30 A to 69.30 A	6.30 A to 69.30 A	
	Positive peak current limit*4	0.50 A to 22.00 A	1.00 A to 44.00 A	2.00 A to 88.00 A	3.00 A to 132.0 A	4.00 A to 176.0 A	6.00 A to 264.0 A	6.00 A to 264.0 A	9.00 A to 396.0 A	9.00 A to 396.0 A	
	Negative peak current limit*4	-0.50 A to -22.00 A	-1.00 A to -44.00 A	-2.00 A to -88.00 A	-3.00 A to -132.0 A	-4.00 A to -176.0 A	-6.00 A to -264.0 A	-6.00 A to -264.0 A	-9.00 A to -396.0 A	-9.00 A to -396.0 A	
	Resolution*5	0.01 A (0.35 A to 100.0 A), 0.1 A (100.0 A to 396.0 A)									
General											
Insulation resistance	Between input and chassis, output and chassis, and input and output	500 Vdc, 30 MΩ or more				500 Vdc, 10 MΩ or more					
Withstand voltage	Between input and chassis, output and chassis, and input and output	1.5 kVAC for 1 minute									
Circuit method	Linear amplifier system										
Environmental conditions	Operating environment	Indoor use, overvoltage category II									
	Operating temperature range	0 °C to +50 °C									
	Storage temperature range	-10 °C to +60 °C									
	Operating humidity range	20 % rh to 80 % rh (no condensation)									
	Storage humidity range	90 % rh or less (no condensation)									
	Altitude	Up to 2000 m									
Weight	Approx.17 kg (37.4 lbs)	Approx. 35 kg (77.1 lbs)	Approx. 55 kg (121.2 lbs)	Approx. 82 kg (180.7 lbs)	Approx. 96 kg (211.6 lbs)	Approx. 140 kg (308.6 lbs)	Approx. 140 kg (308.6 lbs)	Approx. 140 kg (308.6 lbs)	Approx. 190 kg (418.8 lbs)	Approx. 190 kg (418.8 lbs)	
Input terminal	Inlet	M4	M5	M8	M8	M8	M5	M5	M5	M5	
Output terminal	M4	M4	M4	M5	M5	M8	M8	M8	M8	M8	
Accessories	Power cord	1 pc. With plug Length: 3 m	The input power cable is not included. Please refer to the list of ordering information specified on the last page.								
	Setup guide	1 copy									
	Quick Reference	1 each for English and Japanese									
	Safety information	1 copy									
	CD-ROM (User's manual)	1 disc									
Electromagnetic compatibility (EMC) *6, 7	Complies with the requirements of the following directive and standards. EMC Directive 2004/108/EC EN61326-1 (ClassA *8)、EN55011 (ClassA *8、Group1 *9) EN61000-3-2 *10、EN61000-3-3 *10 The maximum length of all cables and wires connected to the PCR-LE Series must be less than 3 m.										
Safety *6	Complies with the requirements of the following directive and standard. Low Voltage Directive 2006/95/EC *7 EN 61010-1 Class I *11, Pollution Degree 2										

*1 Although signals are insulated with output terminals, each signal is common. Logic setting is also possible.

*2 The frequency is limited to the range from 1 Hz to 500.0 Hz when the 3P05-PCR-LE(500HZ LMT) is installed in the PCR-LE series.

*3 The current that can actually be supplied is 1.1 times the rated current or the current limit, whichever is less.

*4 The current that can actually be supplied is the maximum peak current or the current limit, whichever is less.

*5 You can set the current in 0.01 A/ 0.1 A steps, but it may not change at this resolution depending on the relationship with the internal D/A resolution.

*6 Does not apply to specially ordered or modified PCR-LEs.

*7 Only on models that have the CE marking on the panel.

*8 This is a Class A equipment. This product is intended for use in an industrial environment.

This product may cause interference if used in residential areas. Such use must be avoided unless the user takes special measures to reduce electromagnetic emissions to prevent interference to the reception of radio and television broadcasts.

*9 This is a Group 1 equipment. This product does not generate and/or use intentionally radio-frequency energy, in the form of electromagnetic radiation, inductive and/or capacitive coupling, for the treatment of material or inspection/analysis purpose.

*10 PCR500LE、PCR1000LE、PCR2000LE only.

*11 This is a Class I equipment. Be sure to ground this product's protective conductor terminal. The safety of this product is only guaranteed when the product is properly grounded.

Output single-phase, single-phase 3-wire,* Convenient multiple output supports a wide AC power supply offering superior space factor

High-performance AC Power Supplies **PCR-LE2 SERIES**

The PCR-LE2 Series are designed based on the PCR-LE Series that supports single-phase output, single-phase 3-wire output*, and three-phase output within the rated capacity by selecting the switch from the front panel operation. The PCR-LE2 series offer the same basic performance, using the common power unit of the PCR-LE Series, with providing easier installation and saving the space more efficiently compare to the individual allocation of the system for a single-phase, single-phase 3-wire, and three-phase systems. The lineup of PCR-LE2 Series are available in 3 models: 6 kVA, 9 kVA, 12 kVA, 18 kVA, and 27 kVA model.

*2/3 of the rated output power



Single-phase output display screen



Single-phase 3-wire output display screen



Three phase output display screen



and three-phase power with a single unit. range of industrial devices. and cost performance.

*: The Output power with single-phase 3-wire limits 2/3 of the rated output.

● Lineup

Model		PCR6000LE2	PCR9000LE2	NEW PCR12000LE2	NEW PCR18000LE2	PCR27000LE2
Output capacity	Single-phase, Three phase 4-wire	6 kVA	9 kVA	12 kVA	18 kVA	27 kVA
	Single phase 3-wire	4 kVA	6 kVA	9 kVA	12 kVA	18 kVA
Maximum output current	Single-phase	60 A / 30 A	90 A / 45 A	120 A / 60 A	180 A / 90 A	270 A / 135 A
	Single phase 3-wire	20 A / 10 A	30 A / 10 A	40 A / 20 A	60 A / 30 A	90 A / 45 A
1 V to 150 V / 2 V to 300 V						
AC mode (L/H range)	Single-phase	60 A / 30 A	90 A / 45 A	120 A / 60 A	180 A / 90 A	270 A / 135 A
	Three phase 4-wire	20 A / 10A	30 A / 15 A	40 A / 20 A	60 A / 30 A	90 A / 45 A
1.4 V to 212 V / 2.8 V to 424 V						
DC mode (L/H range)	Single-phase	42 A / 21 A	63 A / 31.5 A	84 A / 42 A	126 A / 63 A	189 A / 94.5 A
	Single phase 3-wire	14 A / 7A	21 A / 10.5 A	28 A / 14 A	42 A / 21 A	63 A / 31.5 A
Dimensions (mm(inches)) (Maximum dimensions)		430 (16.93") (445 (17.52")) W	430 (16.93") (445 (17.52")) W	(1585 (62.40")) W *OP03-KRC included.	(1585 (62.40")) W *OP03-KRC included.	(1585 (62.40")) W *OP03-KRC included.
		944 (36.17") (1040 (40.94")) H	1325 (52.17") (1420 (55.91")) H	(790 (31.10")) H	(1045 (41.14")) H	(1425 (56.10")) H
		550 (21.65") (595 (23.43")) D	550 (21.65") (595 (23.43")) D	(835 (32.87")) D	(835 (32.87")) D	(835 (32.87")) D
Weight		Approx. 140 kg (308.6 lbs)	Approx. 190 kg (418.8 lbs)	Approx. 350 kg (771.6 lbs)	Approx. 480 kg (1058.2 lbs)	Approx. 630 kg (1388.9 lbs)

● Rear panel



PCR6000LE2

PCR9000LE2

PCR27000LE2

dimensions

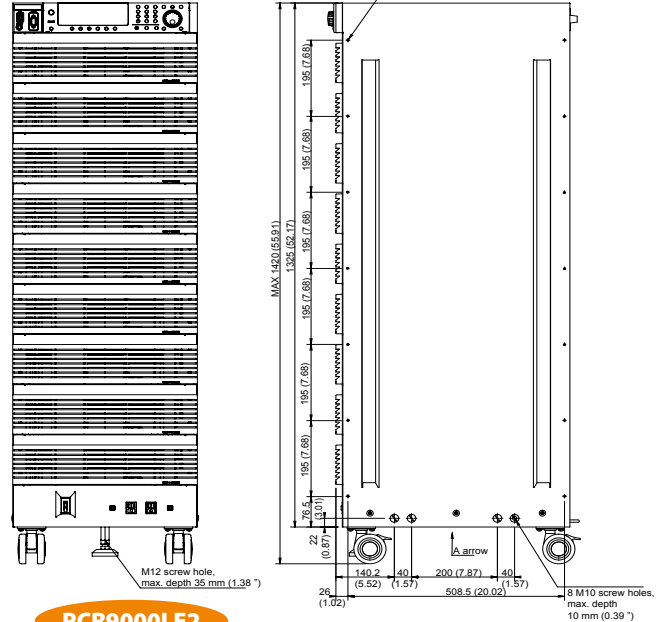
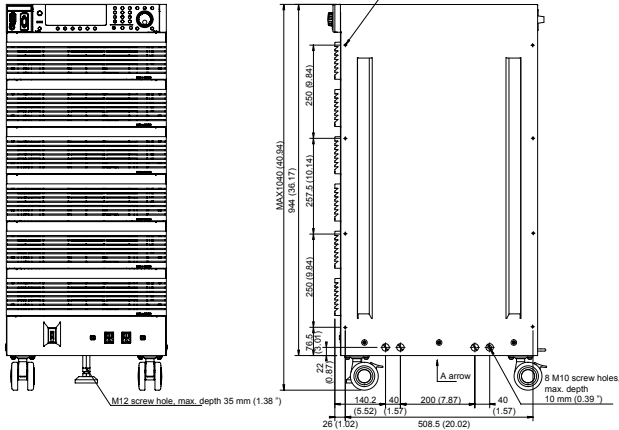
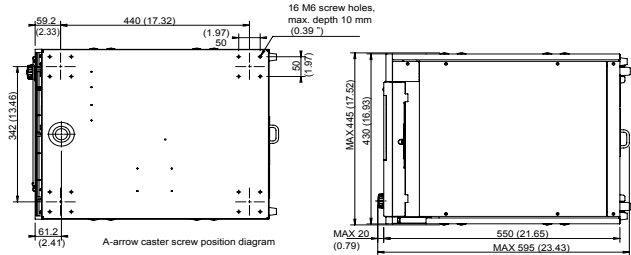
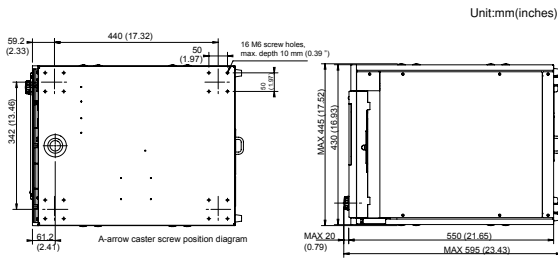

PCR600LE2

PCR900LE2

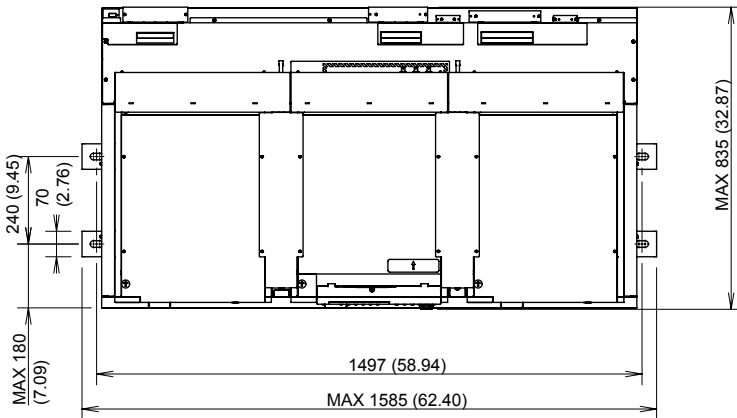

! Concerning installation & relocation PCR1200LE2

- The PCR1200LE2 requires for the installation work. Please consult with your local Kikusui distributor.
- The PCR1200LE2 cannot be relocated after it is installed. If relocation becomes necessary, please consult with your local Kikusui distributor.

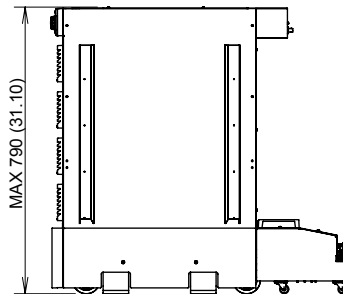
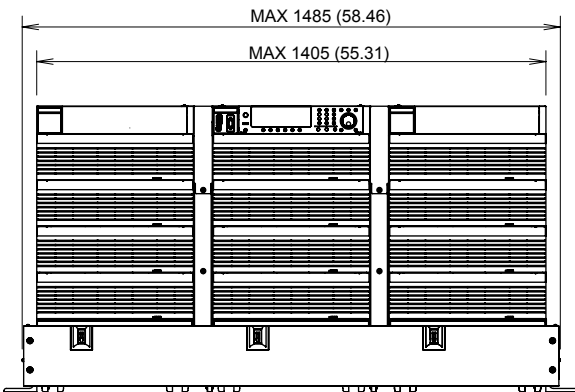

PCR1200LE2

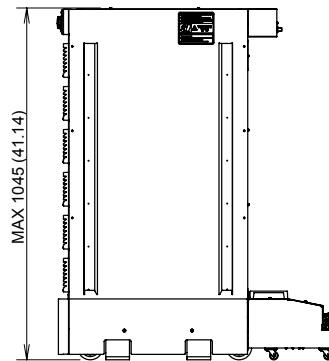
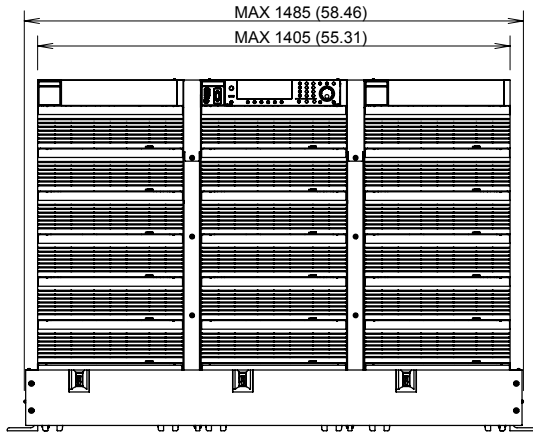
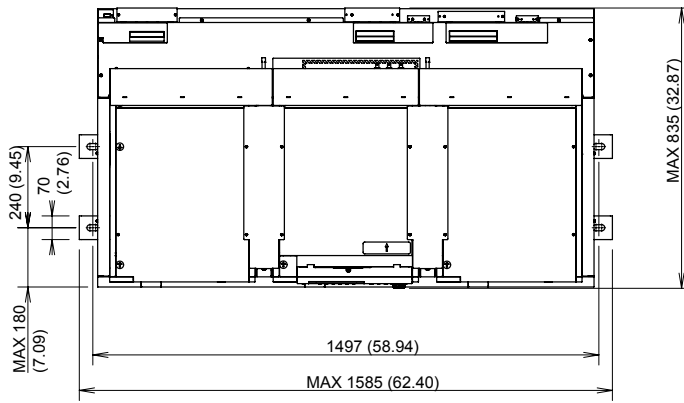

PCR18000LE2



Concerning installation & relocation PCR18000LE2

- The PCR18000LE2 requires for the installation work. Please consult with your local Kikusui distributor.
- The PCR18000LE2 cannot be relocated after it is installed. If relocation becomes necessary, please consult with your local Kikusui distributor.

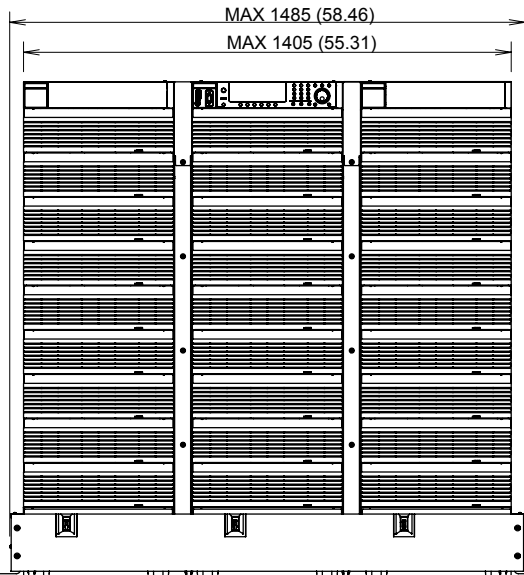
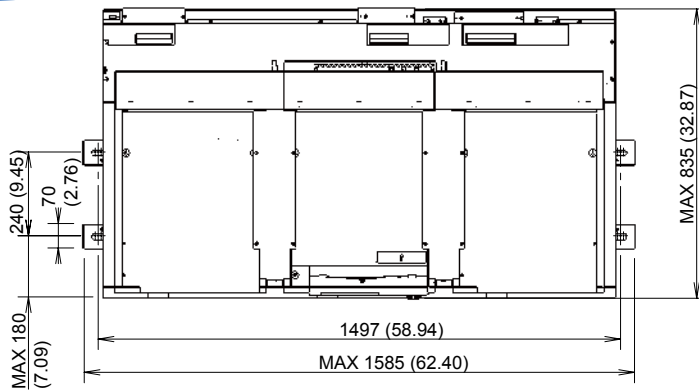

Concerning installation & relocation PCR27000LE2

- The PCR27000LE2 requires for the installation work. Please consult with your local Kikusui distributor.
- The PCR27000LE2 cannot be relocated after it is installed. If relocation becomes necessary, please consult with your local Kikusui distributor.

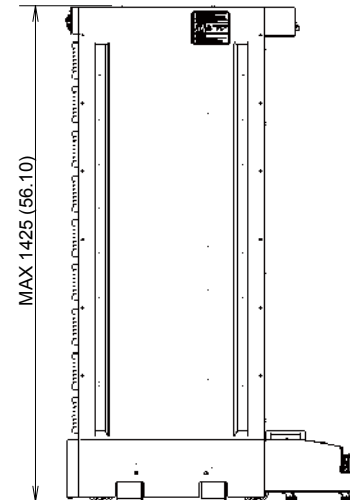

PCR27000LE2

specifications

Item/Model	PCR6000LE2			PCR9000LE2	
Input ratings (AC rms)	1P2W	3P3W200V	3P4W400V	3P3W200V	3P4W400V
Voltage	Line voltage 170 V to 250 V		Line voltage 324 V to 440 V (Phase voltage 187 V to 254 V)	Line voltage 170 V to 250 V	Line voltage 324 V to 440 V (Phase voltage 187 V to 254 V)
Phases	Single phase	Three phase 3-wire	Three phase 4-wire	Three phase 3-wire	Three phase 4-wire
Frequency	47 Hz to 63 Hz				
Apparent power	Approx. 10.6 kVA			Approx. 15.7 kVA	
Power factor *1				0.97 (TYP)	
Max. current	64 A or less	38 A or less	21 A or less	55 A or less	30 A or less
AC mode output ratings (AC rms)					
Voltage (output L range, output H range)*2	1 V to 150 V / 2 V to 300 V				
Voltage setting range	0 V to 152.5 V / 0 V to 305.0 V				
Voltage setting accuracy (output L range, output H range)*3	±(0.3 % of set + 0.6 V)				
Max. current*4	Single phase, poly phase, L range, H range	60 A, 30 A · 20 A, 10 A		90 A, 45 A · 30 A, 15 A	
Phase*5	Single phase · Single phase 3-wire · Three phase 4-wire				
Power capacity	Single phase, Three phase 4-wire, Single phase 3-wire	6 kVA · 4 kVA		9 kVA · 6 kVA	
Maximum peak current*6				Max. current (rms) × 4 (TYP)	
Max. reverse current*7				30 % of the max. current (rms)	
Load power factor*4				0 to 1 (leading or lagging)	
Frequency*4 *8 *9				1 Hz to 999.9 Hz ★	
DC mode output ratings, AC+DC mode (for Single-phase and Single-phase Three-wire output only)					
Voltage (output L range, output H range)*2				±1.4 V to 212 V / ±2.8 V to 424 V	
Voltage setting range				-215.5 V to 215.5 V / -431.0 V to 431.0 V	
Voltage setting accuracy (output L range, output H range) *10				± (0.05 % of set + 0.05 V / 0.1 V)	
Max. current*4	Single phase, Single phase 3-wire and Three-phase, L range, H range	42 A, 21 A · 14 A, 7 A		63 A, 31.5 A · 21 A, 10.5 A	
Max. instantaneous current*11				Max. current (rms) × 3.6	
Power capacity	Single phase, Single phase 3-wire, Three-phase	4.2 kW · 2.8 kW		6.3 kW · 4.2 kW	
Output voltage stability					
Line regulation(With respect to changes in the rated range)				Within ±0.1 %	
Line regulation(With respect to 0 % to 100 % changes in the rating)*12				±0.3 V	
Output frequency variation in AC mode(Between 40 Hz and 999.9 Hz)*13				Within ±0.5 %	
Ripple noise in DC mode(5 Hz to 1 MHz components)				0.25 Vrms or less	
Ambient temperature variation(With respect to changes in the rated range)*14				100 ppm/°C (TYP)	
Output frequency stability, output voltage waveform distortion ratio, output voltage response speed, efficiency					
Output frequency stability(With respect to changes in all rated ranges)				Within ±5×10 ⁻³ , Setting accuracy : Within ±1×10 ⁻⁴	
Output voltage waveform distortion ratio*15				0.3 % or less	
Output voltage response speed*16				30 μs (TYP)	
Efficiency*1				58 % or more	
Phase difference of the output phase voltage*17	Resolution	1 deg			
	Accuracy	Within ± (0.4° + f0×1.8×10 ⁻³) deg		f0 is the output frequency *18	
Meters (fluorescent display)					
Voltmeter	Resolution	RMS,AVE Display mode		0.1 V	
*19 *20	Accuracy	RMS,AVE Display mode		Within ± (1 % of rdng + 2 digits) (10 V to 848 V and at room temperature)	
Ammeter	Resolution	RMS,AVE Display mode Single phase · Poly phase		0.1 A · 0.01 A	
*19 *20	Accuracy	RMS Display mode		Within ± (1% of reading + 2digits) (5 % of the max. rated current to max. rated current and at room temperature)	
Wattmeter*20	Resolution	Single phase · Poly phase		1 W · 0.1 W / 1 W	
	Accuracy			Within ± (1 % of reading + 3digits) (10 % of the rated power capacity to the rated power capacity, when the load power factor is 1, and at room temperature.)	
Frequency meter*21	Resolution			0.01 Hz / 0.1 Hz	
General					
Insulation resistance	Between input and chassis, output and chassis, and input and output		500 V, 10 MΩ or more		
Withstand voltage			1.5 kVAC for 1 minute		
Circuit method			Linear amplifier system		
Environmental conditions	Operating temperature range / Storage temperature range		0 °C to +50 °C / -10 °C to +60 °C		
	Operating humidity range / Storage humidity range		20 % rh to 80 % rh (no condensation) / 90 % rh or less (no condensation)		
Weight			Approx. 140 kg(308.6 lbs)		Approx. 190kg(418.8 lbs)
Input terminal	Input terminal board [3 φ]	M8	M5	M5	
Output terminal	Output terminal board Single phase · Single phase 3-wire, Three-phase 4-wire	M8 · M5			
Input power cord [Sold separately option]	Shape	single-core cable			
	The number	3 pc	4 pc	5 pc	4 pc
	Conductor cross section/Length	14 mm ² / 3 m	8 mm ² / 3 m	5.5 mm ² / 3 m	14 mm ² / 3 m
Accessories	Setup guide	1 copy			
	Quick Reference	1 each for English and Japanese			
	Safety information	1 copy			
	CD-ROM(User's manual)	1 disc			
Other	Electromagnetic compatibility (EMC)	EMC Directive 2004/108/EC, EN61326-1, EN61000-3-2, 3-3 The maximum length of all cables and wires connected to the PCR-LE Series must be less than 3 m.			
	Safety	Low Voltage Directive 2006/95/EC, EN61010-1 Class I Pollution Degree2			
	Output voltage ratio versus rated output current characteristics	PCR-LE series just like. (See P. 23.)			

*1 When the output phase voltage is 100 V or 200 V, the output current is the rated value, the load power factor is 1, and the output frequency is between 40 Hz and 999.9 Hz.

*2 L/H range can be changed by means of a switch on the front panel. Resolution: 0.1 V

*3 When the output frequency is between 45 Hz and 65 Hz, with no load, and at room temperature.

*4 When the maximum voltage is between 1 V and 100 V (L range) or 2 V and 200 V (H range) and the load power factor is between 0.8 and 1. When the output phase voltage is between 100 V and 150 V or 200 V and 300 V (AC mode) or 100 V and 212 V or 200 V and 424 V (DC mode), the output current is reduced by the output phase voltage.

When the load power factor is between 0 and 0.8, the output current is reduced by the load power factor. (AC mode)

When the output frequency is between 1 Hz and 40 Hz, the output current is reduced by the output frequency. (AC mode)

*5 The output phase mode can be changed by means of a key on the operation panel. "Poly" in the table indicates single-phase three-wire mode and three-phase four-wire mode.

*6 When the output phase voltage is in the vicinity of the peak (±15 deg) (However, this is limited by the rated output current's rms value).

*7 When the output phase voltage is 100 V or 200 V and the output frequency is between 40 Hz and 999.9 Hz (reverse current is -90 deg to -180 deg / 90 deg to 180 deg out of phase with the output voltage).

*8 Resolution: 0.01 Hz (1.00 Hz ~ 100.0 Hz), 0.1 Hz (100.0 Hz ~ 999.9 Hz)

*9 The "500Hz Limit Model" limits the maximum frequency up to 500Hz under the "Three-phase output".

*10 With no load at room temperature

*11 Limited by the rated output current's rms value

*12 When the output phase voltage is between 80 V and 150 V (L range) or 160 V and 300 V (H range) and the load power factor is 1. At the output terminal block. When the response mode is set to MEDIUM, (There is no F mode)

*13 When the output phase voltage is between 80 V and 150 V (L range) or 160 V and 300 V (H range) and the load power factor is 1. This is the output line regulation with 200 Hz as the reference. When the response mode is set to MEDIUM. (There is no F mode)

*14 When the output phase voltage is 100 V or 200 V and the output current is 0 A.

*15 When the output phase voltage is between 80 V and 150 V (L range) or 160 V and 300 V (H range) and the load power factor is 1. When the response mode is set to MEDIUM. (There is no F mode)

*16 When the output phase voltage is 100 V or 200 V, the load power factor is 1, and the output current changes from 0 A to the rated value and from the rated value to 0 A.

*17 Phase difference between output voltages (phase voltages) when each phase is considered along with the neutral point.

*18 The following show the angles obtained by calculating the expression with the specified frequency.

When phase difference is 120 deg.

Within 120 ± 0.5 deg (when generating 60 Hz output)

Within 120 ± 1.2 deg (when generating 400 Hz output)

*19 With the true rms display, a waveform with a crest factor of 3 or less.

*20 When the output frequency is between 45 Hz and 65 Hz.

*21 Displays the output frequency setting (frequency of the internal reference voltage)

★ **PCR-LE2 Series 500Hz Limit Model**
The PCR-LE Series offers the type on each model that limits the maximum output frequency up to 500 Hz.

PCR12000LE2		PCR18000LE2		PCR27000LE2	
3P3W200V	3P4W400V	3P3W200V	3P4W400V	3P3W200V	3P4W400V
Line voltage 170 V to 250 V	Line voltage 324 V to 440 V (Phase voltage 187 V to 254 V)	Line voltage 170 V to 250 V	Line voltage 324 V to 440 V (Phase voltage 187 V to 254 V)	Line voltage 170 V to 250 V	Line voltage 324 V to 440 V (Phase voltage 187 V to 254 V)
Three phase 3-wire	Three phase 4-wire	Three phase 3-wire	Three phase 4-wire	Three phase 3-wire	Three phase 4-wire
47 Hz to 63 Hz					
Approx. 23 kVA		Approx. 33 kVA		Approx. 48 kVA	
0.97 (TYP)					
75 A or less	39 A or less	111 A or less	59 A or less	165 A or less	91 A or less
1 V to 150 V / 2 V to 300 V					
0 V to 152.5 V / 0 V to 305.0 V					
±(0.3 % of set + 0.6 V)					
120 A, 60 A · 40 A, 20 A	180 A, 90 A · 60 A, 30 A		270 A, 135 A · 90 A, 45 A		
Single phase · Single phase 3-wire · Three phase 4-wire					
12 kVA · 8 kVA	18 kVA · 12 kVA		27 kVA · 18 kVA		
Max. current (rms) × 4 (TYP)					
30 % of the max. current (rms)					
0 to 1 (leading or lagging)					
1 Hz to 999.9 Hz ★					
1.4 V to 212 V / 2.8 V to 424 V					
-215.5 V to 215.5 V / -431.0 V to 431.0 V					
± (0.05 % of set + 0.05 V / 0.1 V)					
84A, 42 A · 28 A, 14 A	126A, 63 A · 42 A, 21 A		189 A, 94.5 A · 63 A, 31.5 A		
Max. current (rms) × 3.6					
8.4 kW · 5.6 kW	12.6 kW · 8.4 kW		18.9 kW · 12.6 kW		
Within ±0.1 %					
±0.5 V					
Within ±1 %					
0.5 Vrms or less					
100 ppm/°C (TYP)					
Within ±5×10 ⁻⁵ , Setting accuracy : Within ±1×10 ⁻⁴					
0.5 % or less					
50 μs (TYP)					
58 % or more					
1 deg					
Within ± (0.4° + f0×1.8×10 ⁻³) deg f0 is the output frequency *18					
0.1 V					
Within ± (1 % of rdng + 2 digits) (10 V to 848 V and at room temperature)					
0.1 A				0.1 A / 1 A · 0.1 A	
Within ± (1% of reading + 2digits) (5 % of the max. rated current to max. rated current and at room temperature)					
1 W / 10 W					
Within ± (1 % of reading + 3digits) (10 % of the rated power capacity to the rated power capacity, when the load power factor is 1, and at room temperature.)					
0.01 Hz / 0.1 Hz					
500 V, 10 MΩ or more					
1.5 kVAC for 1 minute					
Linear amplifier system					
0 °C to +50 °C / -10 °C to +60 °C					
20 % rh to 80 % rh (no condensation) / 90 % rh or less (no condensation)					
Approx.350 kg(771.6 lbs)	Approx.480 kg(1058.2 lbs)		Approx.630 kg(1388.9 lbs)		
M8	M8		M8		
M8·M8					
Required for the installation work, contact local distributor.					
1 copy					
1 each for English and Japanese					
1 copy					
1 disc					
EMC Directive 2004/108/EC, EN61326-1, EN61000-3-2, 3-3 The maximum length of all cables and wires connected to the PCR-LE Series must be less than 3 m.				—	
Low Voltage Directive 2006/95/EC, EN61010-1 Class I Pollution Degree2					
PCR-LE series just like.(See P.23.)					

specifications

Item/Model		PCR6000LE2	PCR9000LE2	PCR12000LE2	PCR18000LE2	PCR27000LE2	
Limit Values and Protection Functions							
Voltage	AC voltage upper limit AC voltage lower limit	0.0 V to 305.0 V					
	DC voltage upper limit DC voltage lower limit	-431.0 V to +431.0 V					
	Output overvoltage protection AC/AC+DC mode	0.0 V to 474.1 V					
	Output overvoltage protection DC mode	-474.1 V to +474.1 V					
	Output undervoltage protection AC/AC+DC mode	0.0 V to 474.1 V					
	Output undervoltage protection DC mode	-474.1 V to +474.1 V					
	Resolution	0.1 V					
Frequency	Upper limit Lower limit	1 Hz to 999.9 Hz, 500 Hz LMT model: 1 Hz to 500 Hz (Three-phase output)					
	Resolution	0.01 Hz (1.00 Hz to 100.0 Hz), 0.1 Hz (100.0 Hz to 999.9 Hz)					
Current	Current limit *1 AC mode	Single-phase output	6.00 A to 66.00 A	9.00 A to 99.00 A	12.00 A to 132.0 A	18.00 A to 198.0 A	27.00 A to 297.0 A
		Single-phase three-wire output Three-phase output	2.00 A to 22.00A	3.00 A to 33.00 A	4.00 A to 44.00 A	6.00 A to 66.00 A	9.00 A to 99.00 A
	Current limit *1 DC/AC+DC mode	Single-phase output	4.20A to 46.20A	6.30 A to 69.30 A	8.40 A to 92.40 A	12.60 A to 138.6 A	18.90 A to 207.9 A
		Single-phase three-wire output Three-phase output	1.40A to 15.40A	2.10 A to 23.10 A	2.80 A to 30.80 A	4.20 A to 46.20 A	6.30 A to 69.30 A
	Positive peak current limit *2	Single-phase output	6.00A to 264.0A	9.00 A to 396.0 A	12.00 A to 528.0 A	18.00 A to 792.0 A	27.00 A to 1188 A
		Single-phase three-wire output Three-phase output	2.00A to 88.00A	3.00 A to 132.0 A	4.00 A to 176.0 A	6.00 A to 264.0 A	9.00 A to 396.0 A
	Negative peak current limit *2	Single-phase output	-6.00A to -264.0A	-9.00 A to -396.0 A	-12.00 A to -528.0 A	-18.00 A to -792.0 A	-27.00 A to -1188 A
Single-phase three-wire output Three-phase output		-2.00A to -88.00A	-3.00 A to -132.0 A	-4.00 A to -176.0 A	-6.00 A to -264.0 A	-9.00 A to -396.0 A	
	Resolution *3	0.01 A (0.35 A to 100.0 A) , 0.1A (100.0 A to 1000 A) , 1 A (1000 A to 1188 A)					

*1 The current that can actually be supplied is 1.1 times the rated current or the current limit, whichever is less.

*2 The current that can actually be supplied is the maximum peak current or the current limit, whichever is less.

*3 You can set the current in 0.01 A/ 0.1 A/ 1 A steps, but it may not change at this resolution depending on the relationship with the internal D/A resolution.

common specifications

■ Rated output current characteristics (Derating)

The output voltage ratio is a percentage where 100 % represents an output voltage of 100 V (output L range) or 200 V (output H range) in AC mode or DC mode.

The output current ratio is a percentage where 100 % represents the maximum rated output current in AC mode or DC mode.

■ Output voltage ratio versus rated output current characteristics (AC mode)

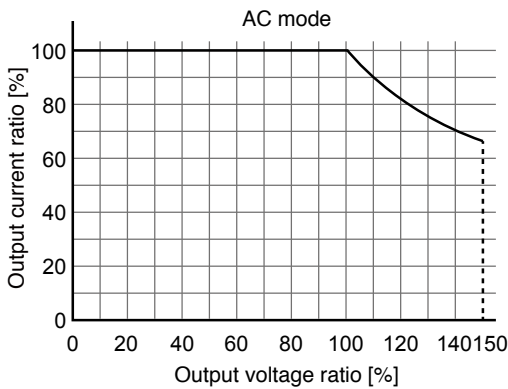

■ Load power factor versus rated output current characteristics

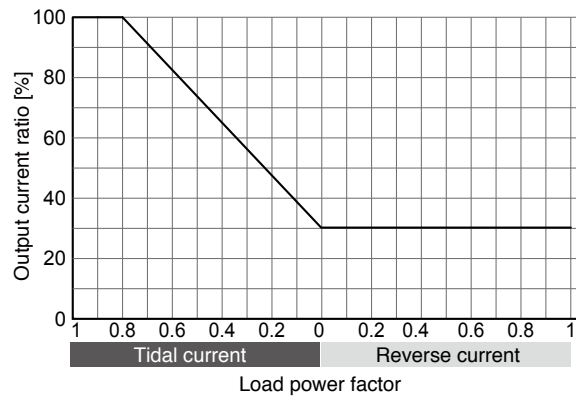

■ Output voltage ratio versus rated output current characteristics (DC mode)

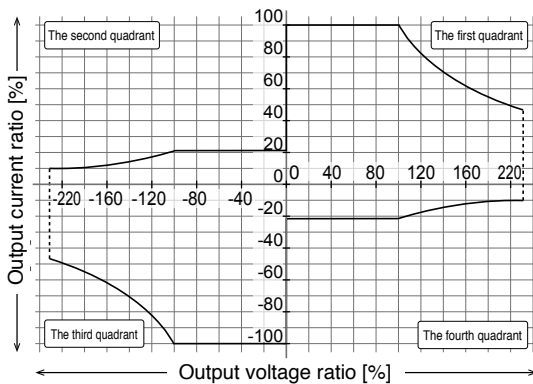

■ Output frequency versus rated output current characteristics

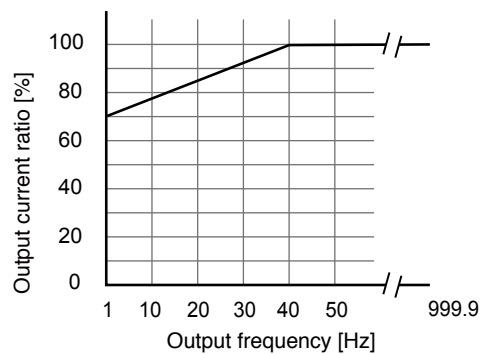

For the “Output voltage ratio versus rated output current characteristics (AC mode)” and “Load power factor versus rated output current characteristics” graphs, the rated output current is the product of the output current ratios shown in both graphs. The output current ratio shown in the “Output frequency versus rated output current characteristics” graph is given priority if it is less than the product of the output current ratios described above. (This only applies to AC mode.)

High-performance multifunctional PCR-LE/ LE2 SERIES SELECTION

Extended system for large capacity applications. Flexible configuration in models.

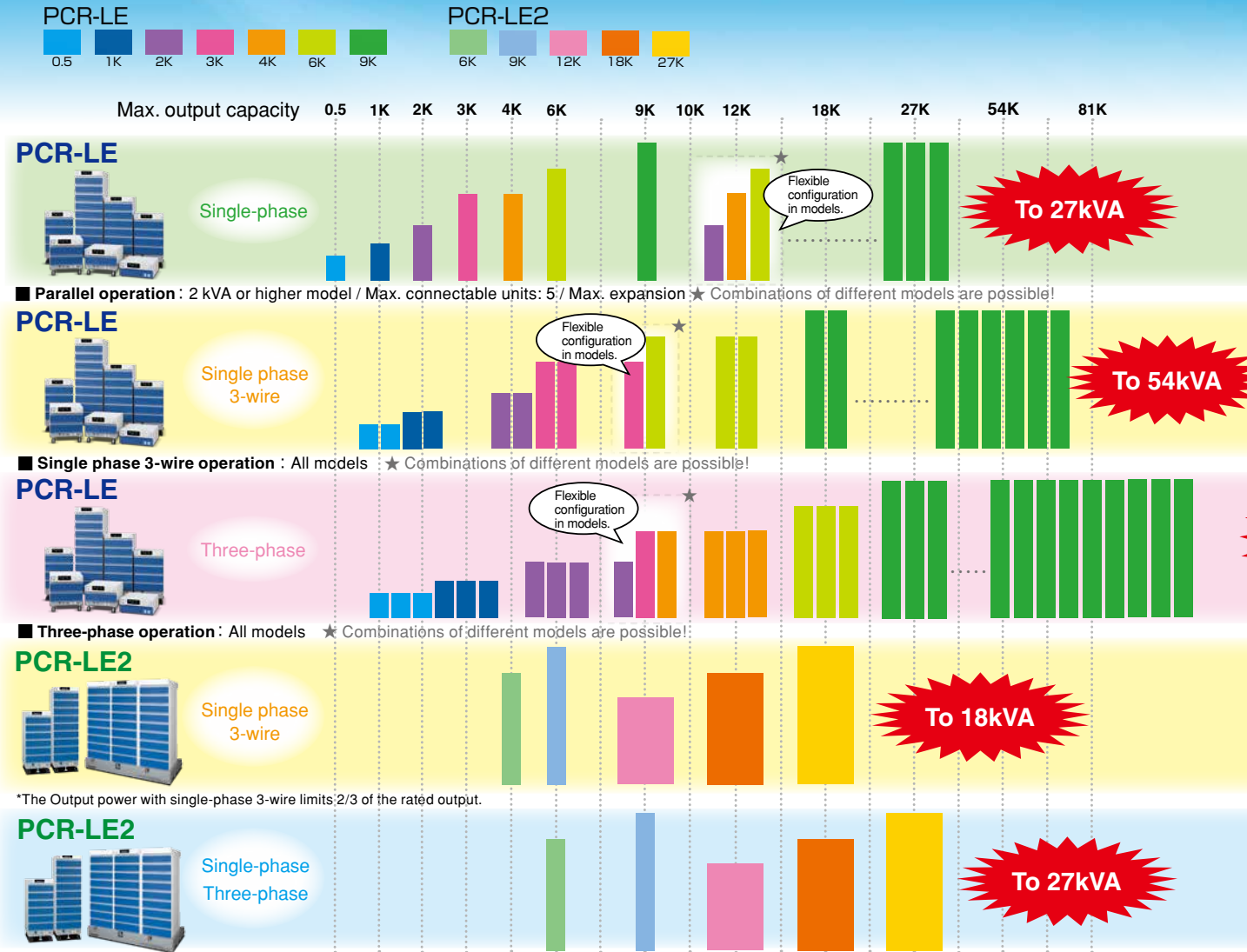

Ordering information The system configuration (Model and Options)

Part	Model			
	Model	Dimensions (Maximum dimensions)	Weight	Power cable
High-performance AC Power Supplies (Single phase)	PCR500LE	(430 (16.93")) Wx173 (6.81" (195 (7.68")) Hx550(21.65/600 (23.62")) Dmm	Approx. 17 kg(37.4 lbs)	Included as a standard accessory
	PCR1000LE	(430) Wx262 (345) Hx550(595) Dmm	Approx. 35 kg(77.1 lbs)	AC5.5-3P3M-M4C
	PCR2000LE	(430) Wx389 (475) Hx550(595) Dmm	Approx. 55 kg(121.2 lbs)	AC8-1P3M-M5C-3S
	PCR3000LE	430 (445) Wx690 (785) Hx550 (595) Dmm	Approx. 82 kg(180.7 lbs)	AC14-1P3M-M8C-3S
	PCR4000LE	430 (445) Wx690 (785) Hx550 (595) Dmm	Approx. 96 kg(211.6 lbs)	AC22-1P3M-M8C-3S
	PCR6000LE	430 (445) Wx944 (1040) Hx550 (595) Dmm	Approx. 140 kg (308.6 lbs)	AC14-1P3M-M8C-3S
	PCR6000LE (3P3W 200V)	430 (445) Wx944 (1040) Hx550 (595) Dmm	Approx. 140 kg (308.6 lbs)	AC14-1P3M-M5C-4S
	PCR6000LE (3P4W 400V)	430 (445) Wx944 (1040) Hx550 (595) Dmm	Approx. 140 kg (308.6 lbs)	AC5.5-1P3M-M5C-5S
	PCR9000LE (3P3W 200V)	430 (445) Wx1325 (1420) Hx550 (595) Dmm	Approx. 190 kg(418.8 lbs)	AC14-1P3M-M5C-4S
	PCR9000LE (3P4W 400V)	430 (445) Wx1325 (1420) Hx550 (595) Dmm	Approx. 190 kg(418.8 lbs)	AC5.5-1P3M-M5C-5S
	PCR6000LE2	430 (445) Wx944 (1040) Hx550 (595) Dmm	Approx. 140 kg (308.6 lbs)	AC14-1P3M-M8C-3S
	PCR6000LE2 (3P3W 200V)	430 (445) Wx944 (1040) Hx550 (595) Dmm	Approx. 140 kg (308.6 lbs)	AC14-1P3M-M5C-4S
PCR6000LE2 (3P4W 400V)	430 (445) Wx944 (1040) Hx550 (595) Dmm	Approx. 140 kg (308.6 lbs)	AC5.5-1P3M-M5C-5S	
PCR9000LE2 (3P3W 200V)	430 (445) Wx1325 (1420) Hx550 (595) Dmm	Approx. 190 kg(418.8 lbs)	AC14-1P3M-M5C-4S	
PCR9000LE2 (3P4W 400V)	430 (445) Wx1325 (1420) Hx550 (595) Dmm	Approx. 190 kg(418.8 lbs)	AC5.5-1P3M-M5C-5S	
High-performance AC Power Supplies (Single phase / Single phase three wire / Three-phase switchable type)	PCR12000LE2 (3P3W 200V)	(1585) Wx (790) Hx (835) Dmm	Approx. 350 kg(771.6 lbs)	Included in the installation fee. *The installation fee is required as an additional cost *In case of re-location of the system *Please consult with your local distributor.
	PCR12000LE2 (3P4W 400V)	(1585) Wx (790) Hx (835) Dmm	Approx. 350 kg(771.6 lbs)	
	PCR18000LE2 (3P3W 200V)	(1585) Wx (1045) Hx (835) Dmm	Approx. 480 kg(1058.2 lbs)	
	PCR18000LE2 (3P4W 400V)	(1585) Wx (1045) Hx (835) Dmm	Approx. 480 kg(1058.2 lbs)	
	PCR27000LE2 (3P3W 200V)	(1585) Wx (1425) Hx (835) Dmm	Approx. 630 kg(1388.9 lbs)	
	PCR27000LE2 (3P4W 400V)	(1585) Wx (1425) Hx (835) Dmm	Approx. 630 kg(1388.9 lbs)	

AC Power Supplies GUIDE

New stage of AC power supply supporting new energy field

The PCR-LE Series is a high performance and multifunctional AC power supply. It can be used as a high quality and stability of the regulated power supply and it controls the waveform freely of the broadband frequency by taking the advantage characteristics of the linear amplifier method. Furthermore, it supports the low frequency immunity test and various power environment tests combined with various options. The options are available for the Parallel Operation, Single-phase Three-wires Operation, and Three-phase Operation that enables you to expand the system for the Single-phase Operation up to 27kVA, Single-phase Three-wires Operation up to 54kVA, and Three-phase Operation up to 81kVA for which systems can be applied to the large-scale EMC testing site. The PCR-LE Series are available in total of 7 models for 0.5kVA, 1kVA, 2kVA, 3kVA, 4kVA, 6kVA, and 9kVA model.

The PCR-LE2 Series are designed based on the PCR-LE Series that supports single-phase output, single-phase 3-wire output *, and three-phase output within the rated capacity by selecting the switch from the front panel operation. The PCR-LE2 series offer the same basic performance, using the common power unit of the PCR-LE Series, with providing easier installation and saving the space more efficiently compare to the individual allocation of the system for a single-phase, single-phase 3-wire, and three-phase systems. The lineup of PCR-LE2 Series are available in 3 models: 6 kVA, 9 kVA, 12 kVA, 18 kVA, and 27 kVA model.

*2/3 of the rated output power

PCR-LE Series



- High-quality/high-stability output with a high-speed linear amp
- Capable of various power line abnormality simulations and the sequence operation
- Single phase 500 VA to 9 kVA, supporting the system for the single-phase, and expandable with optional drivers for the single-phase three-wire, and three-phase operation
- Expandable capacity up to 27 kVA (single-phase), 54 kVA (single-phase three-wires), and 81 kVA (three-phase)
- Equipped with various measuring functions
- Features a full range of measuring functions and supports AC, DC, and AC + DC Outputs
- Detachable front panel
- Eco-friendly function equipped

PCR-LE2 Series



- High-quality/high-stability output with a high-speed linear amp
- Capable of various power line abnormality simulations and the sequence operation
- Single-phase 6 kVA to 27 kVA, Capable of the Single-phase output, Single-phase 3-wire output, and Three-phase output.
- Equipped with various measuring functions
- Features a full range of measuring functions and supports AC, DC, and AC + DC Outputs
- Detachable front panel
- Eco-friendly function equipped

To 81kVA
*Applied to
108kVA,
135kVA !

*Subject to the custom products

Option										
Parallel operation driver	Single-phase three-wire output driver	Three-phase output driver	Extension cable	Extension connection cable	Extension power signal cable	Power-sync cable	Rack mount	Interface	Analog	control panel
—	2P05-PCR-LE	3P05-PCR-LE	CC01-PCR-LE (1.5m)	PC01-PCR-LE (1.3m)	CC11-PCR-LE (1m)	LC01-PCR-LE (1m)	KRB4 KRB200 (PCR500LE)	IB05-PCR-LE (GPIO Interface)	EX05-PCR-LE	EC05-PCR (2m)
PD05M-PCR-LE (Master)		3P05-PCR-LE (500Hz LMT)	CC02-PCR-LE (2.8m) ※ 2P05/3P05				KRB6 KRB300 (PCR1000LE)			
PD05S-PCR-LE (Slave)	※ Overseas export	—	—	—	—	—	KRB9 KRB400-PCR-LE (PCR2000LE)	LN05-PCR-LE (LAN Interface)	—	—
—	—	—	—	—	—	—	—	—	—	—

*Any one of the following can be installed.

*Single-phase operation only for the PCR6000LE2, PCR9000LE2
*Any one of the following can be installed.

ordering information

Part	Model	Remarks	
High-performance AC Power Supplies (Single phase)	PCR500LE	Single phase 500VA	
	PCR1000LE	Single phase 1kVA	
	PCR2000LE	Single phase 2kVA	
	PCR3000LE	Single phase 3kVA	
	PCR4000LE	Single phase 4kVA	
	PCR6000LE	Single phase 6kVA	
	PCR9000LE	Single phase 9kVA	
High-performance AC Power Supplies (Single phase/Single phase three wire/Three-phase switchable type)	PCR6000LE2	Single phase / Three-phase 6kVA, Single phase three wire 4kVA	
	PCR9000LE2	Single phase / Three-phase 9kVA, Single phase three wire 6kVA	
	PCR12000LE2	Single phase / Three-phase 12kVA, Single phase three wire 9kVA	
	PCR18000LE2	Single phase / Three-phase 18kVA, Single phase three wire 12kVA	
	PCR27000LE2	Single phase / Three-phase 27kVA, Single phase three wire 18kVA	
GPIO interface	IB05-PCR-LE		
USB interface	US05-PCR-LE		
LAN interface	LN05-PCR-LE		
Analog interface	EX05-PCR-LE	An amplifier type	
	EX06-PCR-LE	Amplitude control type	
Input power cable	For PCR1000LE	AC5.5-3P3M-M4C	3-core cabtire cables 5.5 mm ² /3 m M4
	For PCR2000LE	AC8-1P3M-M5C-3S	3 single-core cables 8 mm ² /3 m M5
	For PCR3000LE/6000LE	AC14-1P3M-M8C-3S	3 single-core cables 14 mm ² /3 m M8
	For PCR4000LE	AC22-1P3M-M8C-3S	3 single-core cables 22 mm ² /3 m M8
	For PCR6000LE (Three-phase 200V) /9000LE (Three-phase 200V)	AC14-1P3M-M5C-4S	4 single-core cables 14 mm ² /3 m M5
	For PCR6000LE (Three-phase 400V) /9000LE (Three-phase 400V)	AC5.5-1P3M-M5C-5S	5 single-core cables 5.5 mm ² /3 m M5
	For PCR6000LE2	AC14-1P3M-M8C-3S	3 single-core cables 14 mm ² /3 m M8
	For PCR6000LE2 (Three-phase 200V) /9000LE2 (Three-phase 200V)	AC14-1P3M-M5C-4S	4 single-core cables 14 mm ² /3 m M5
For PCR6000LE2 (Three-phase 400V) /9000LE2 (Three-phase 400V)	AC5.5-1P3M-M5C-5S	5 single-core cables 5.5 mm ² /3 m M5	
Extension cable for control panel	EC05-PCR	2m	
Parallel operation driver (Master)	PD05M-PCR-LE	Cannot be used with PCR500LE or PCR1000LE.	
Parallel operation driver (Slave)	PD05S-PCR-LE	Cannot be used with PCR500LE or PCR1000LE.	
Single-phase three-wire output driver	2P05-PCR-LE		
Three-phase output driver	3P05-PCR-LE		
	3P05-PCR-LE (500Hz LMT)	Overseas export	
Extension cable	CC01-PCR-LE	For 2P05 and 3P05, 1.5 m	
	CC02-PCR-LE	For 2P05 and 3P05, 2.8 m	
Extension connection cable (For parallel operation)	PC01-PCR-LE	1.3 m	
Extension power signal cable (For parallel operation)	CC11-PCR-LE	1 m	
Power-sync cable	LC01-PCR-LE	1 m	
Rack mount Brackets	For PCR500LE	KRB4	For EIA inch size
		KRB200	For JIS metric size
	For PCR1000LE	KRB6	For EIA inch size
		KRB300	For JIS metric size
	For PCR2000LE	KRB9	For EIA inch size
		KRB400-PCR-LE	For JIS metric size
Base holding angle	OP03-KRC	For fixing PCR3000LE/4000LE/6000LE/9000LE/6000LE2/9000LE2 to the floor. Standard accessories for the PCR12000LE2/PCR18000LE2/PCR27000LE2.	
IEC dip simulator	DSI1020	Single phase 20 A	
	DSI3020	Single phase / Three-phase 20 A	
	USB		
	GPIO		
Line impedance network	LIN1020JF	Single phase 20 A	
	LIN3020JF	Single phase / Three-phase 20 A	
	LIN3060J	Single phase / Three-phase 60 A exclusive for the JIS/JET standard	
	OP01-LIN1020JF	LIN1020JF for the "Three-phase" expansion	
Quick Immunity Sequencer 2	SD009-PCR-LE		
Software for creating sequences	SD011-PCR-LE (Wavy for PCR-LE)		
Avionics Test Software	SD012-PCR-LE		
Remote control software for the Windows tablet	SD021-PCR-LE		



KIKUSUI ELECTRONICS CORPORATION

1-1-3, Higashiyamata, Tsuzuki-ku, Yokohama, 224-0023, Japan
Phone: (+81) 45-593-7570, Facsimile: (+81) 45-593-7571, www.kikusui.co.jp

KIKUSUI AMERICA, INC. 1-877-876-2807 www.kikusuiamerica.com

2975 Bowers Avenue, Suite 307, Santa Clara, CA 95051
Phone: 408-980-9433 Facsimile: 408-980-9409

KIKUSUI TRADING (SHANGHAI) Co., Ltd. www.kikusui.cn

Room 216, Building 4, No.641, Tianshan Road, Shanghai City, China
Phone: 021-5887-9067 Facsimile: 021-5887-9069

For our local sales distributors and representatives, please refer to "sales network" of our website.

●Distributor/Representative

■ All products contained in this catalogue are equipment and devices that are premised on use under the supervision of qualified personnel, and are not designed or produced for home-use or use by general consumers. ■ Specifications, design and so forth are subject to change without prior notice to improve the quality. ■ Product names and prices are subject to change and production may be discontinued when necessary. ■ Product names, company names and brand names contained in this catalogue represent the respective registered trade name or trade mark. ■ Colors, textures and so forth of photographs shown in this catalogue may differ from actual products due to a limited fidelity in printing. ■ Although every effort has been made to provide the information as accurate as possible for this catalogue, certain details have unavoidably been omitted due to limitations in space. ■ If you find any misprints or errors in this catalogue, it would be appreciated if you would inform us. ■ Please contact our distributors to confirm specifications, price, accessories or anything that may be unclear when placing an order or concluding a purchasing agreement.